

ATTENTION!!!
Pour éviter d'abîmer
vos pièces de bois, il
faut les pré-percer
avant de visser.

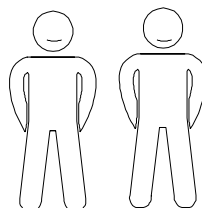
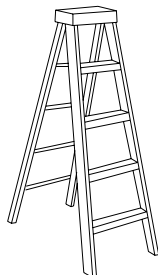

LA 3030

Code EAN : 3701406705380

Colis n° :
(à rappeler impérativement pour
toute demande SAV)

maj 28.01.2026

NOTICE DE MONTAGE
LA 3030

2/12

PLAN DE SOUBASSEMENT

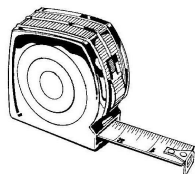
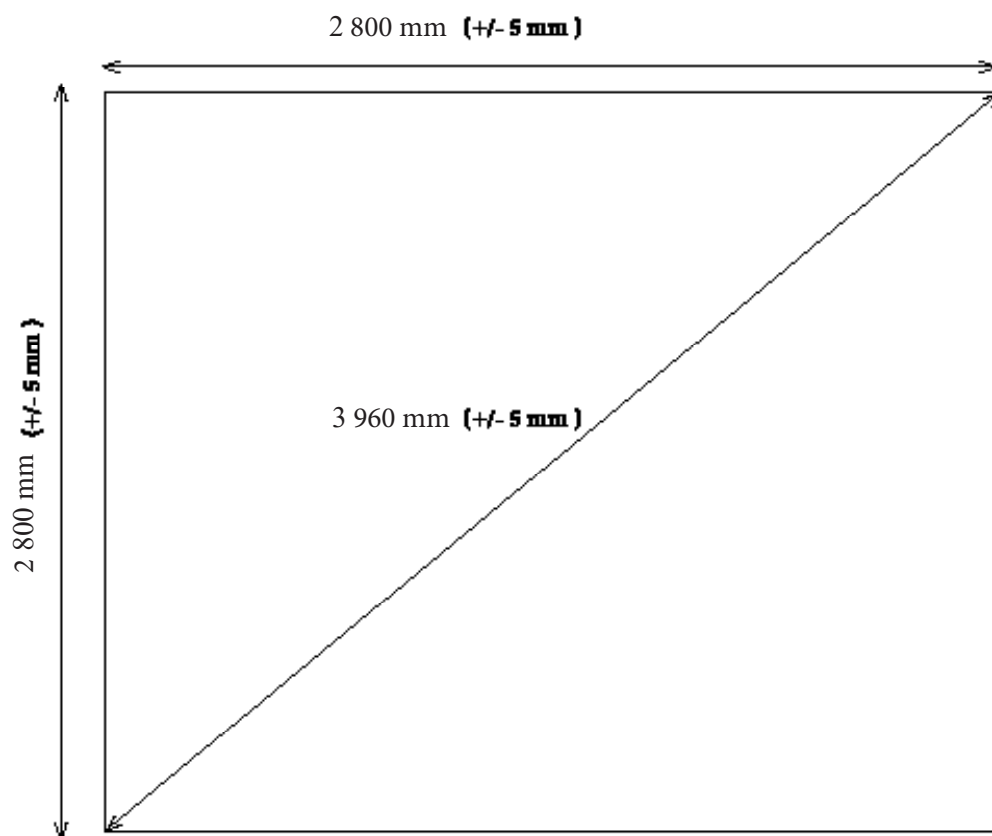









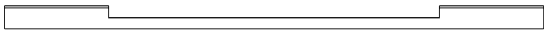



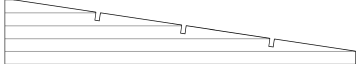





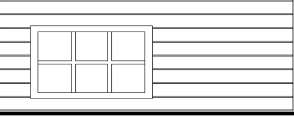
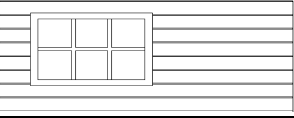

NOTICE DE MONTAGE

3/12

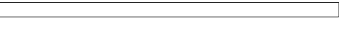
LA 3030

Demande SAV

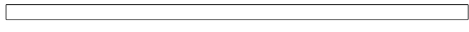
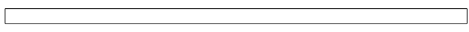







Nr.	Qte	Dessin pièce	Ref	Dimensions	Observation	Qte
1.	1		L28.0.2744d	2744*108* 28		
2.	1		L28.0.2744d	2744*108* 28		
3.	30		L28.0.527	527*108* 28		
4.	23		L28.0.2744	2744*108* 28		
5.	34		L28.0.2744	2744*108* 28		
6.	2		F2744.500	2744*500* 28 à démonter		
7.	3		P3000.90	3000* 90* 40		
8.	2		PF3000.90	3000* 90* 40		
9.	3		PD400.90	400* 90* 40		
11.	2		PF2180.70	2180* 70* 40		
12.	2		PF1780.70	1780* 70* 40		
13.	1		UD1690.48	1690*800* 48		
14.	1		US1690.48	1690*800* 48		
15.	1		TLD1690.68	1690* 80* 68		
16.	1		TLS1690.68	1690* 80* 68		
17.	2		ELT200.70	200* 70* 20		
18.	2		DP810.70	810* 70* 20		
19.	1		EST1680.40	1680* 40* 20		
20.	2		DC2180.90	2180* 90* 20		
21.	2		DC2110.90	2110* 90* 20		
22.	2		DC1780.90	1780* 90* 20		
23.	2		DC1710.90	1710* 90* 20		
24.	8		R680.20	680* 90* 20		
25.	1		DF3040.125	3040* 125* 20		
26.	2		DL3005.125	3005* 125* 20		

maj 28.01.2026

NOTICE DE MONTAGE

LA 3030

4/12

Nr.	Qte	Dessin pièce	Ref	Dimensions	Observation	Qte
28.	2				Verrou a douille	
29.	12			Vis4.0*20		
30.	58			Vis4.0*30		
31.	1			Loquet		
32.	92			Vis4.0*45		
33.	14			Vis5.0*60		
34.	320			Vis4.5*50		
35.	6			ClouL80		
36.	6			Pentures BG150		

A compléter impérativement pour toute demande SAV et à envoyer par mail à sav@foresta.fr + photo des pieces abimes (To be completed imperatively + Photo of damaged parts)

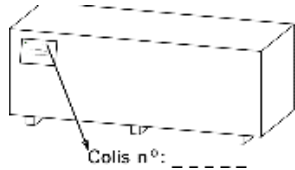
	LA 3030 <u>Colis(package) n° :</u>	MAGASIN (STORE)	
		NOM (NAME) CLIENT	
		PRENOM(PRE.) CLIENT	
		N° de téléphone (PHONE)	

LA 3030

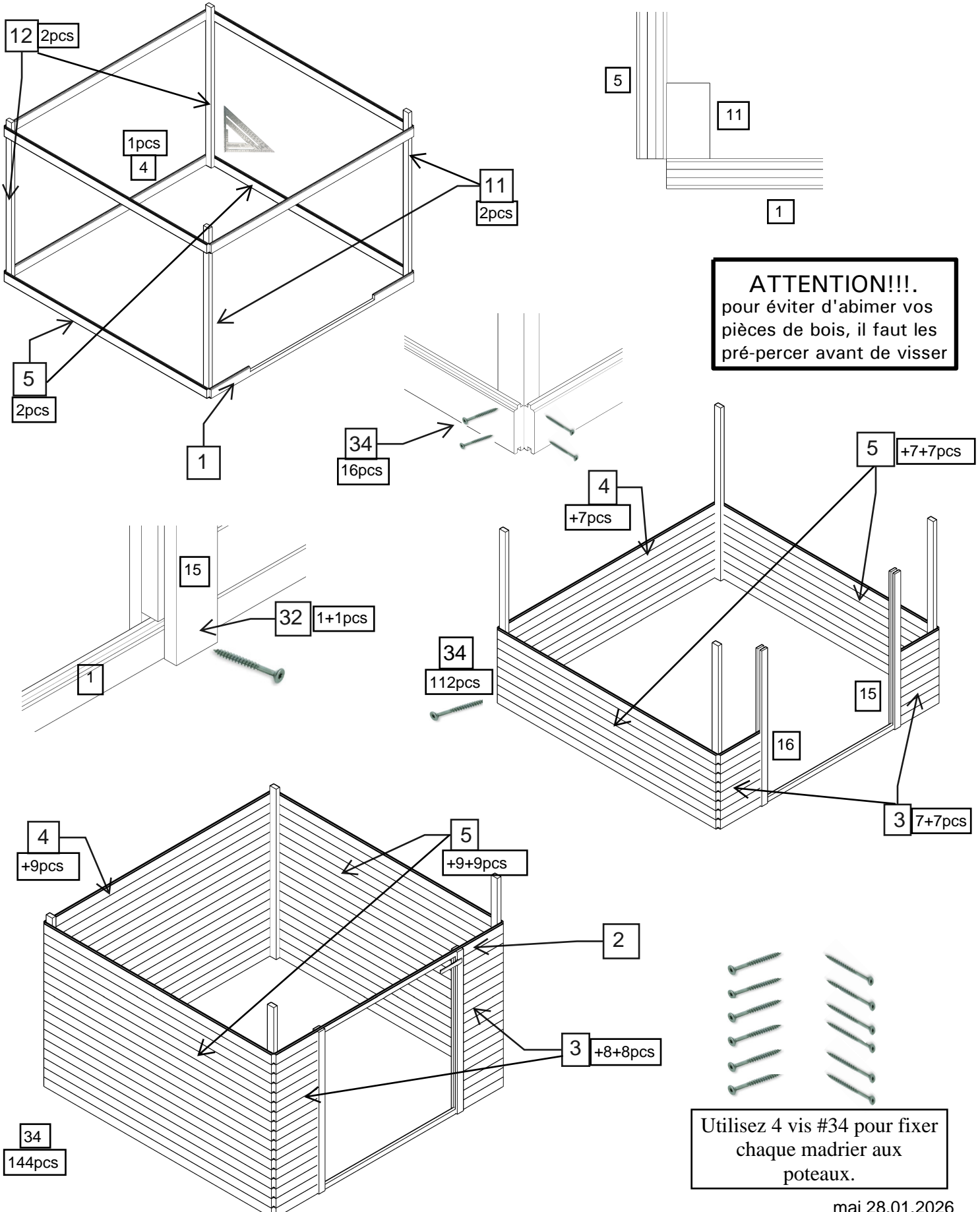

NOTICE DE MONTAGE

LA 3030

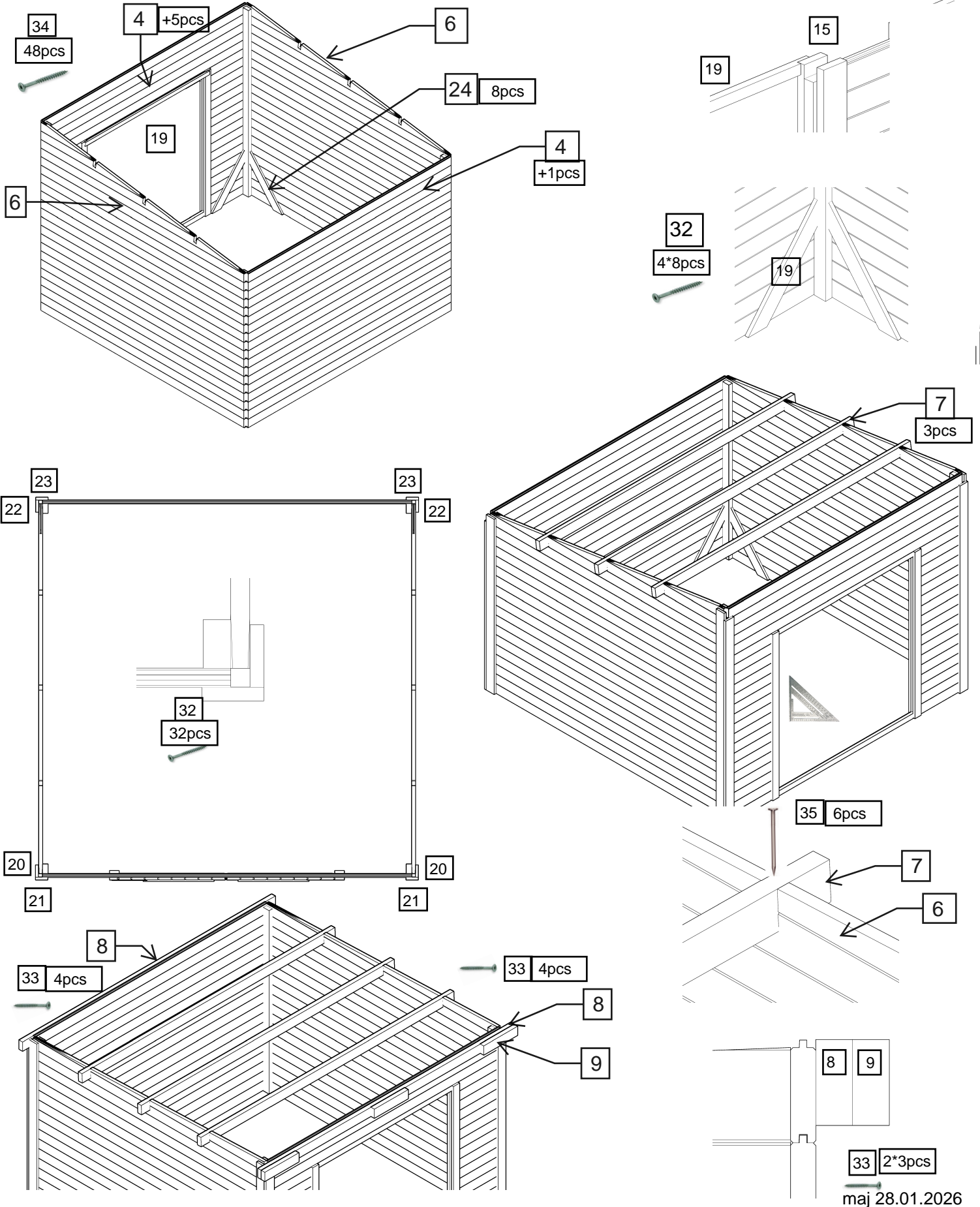

NOTICE DE MONTAGE
LA 3030



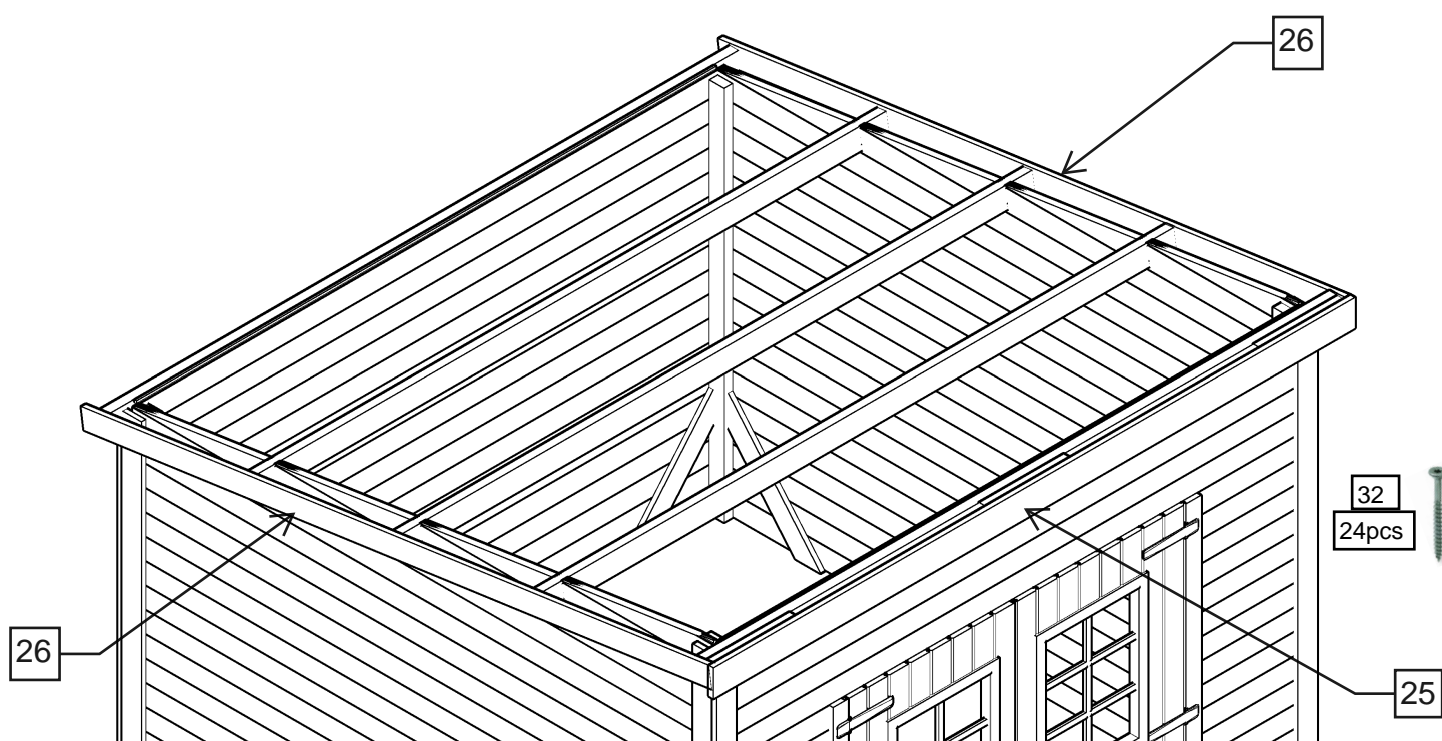



7/12

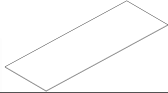

NOTICE DE MONTAGE

8/12

LA 3030

Nr.	Qte	Dessin pièce	Ref	Dimensions	Observation	Qte
P1.	3		POL3000.1000	3000*1000* 6		
P2.	2	 	PRH3000	3000* 30* 6		
P3.	3	 	PRU2000	2000* 20* 6		
P4.	20		VIS	4,5 * 25		

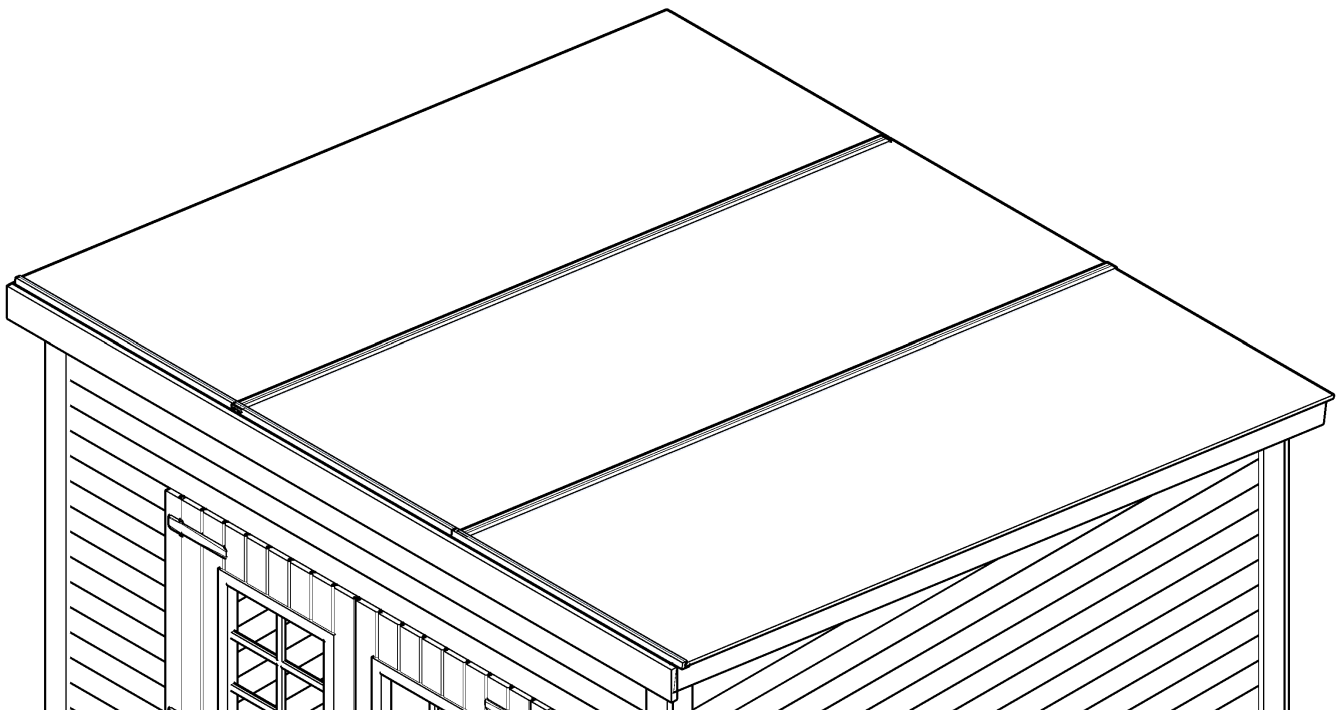

À l'aide d'un cutter, découpez une feuille de polycarbonate à une largeur de 910 mm.



LA 3030

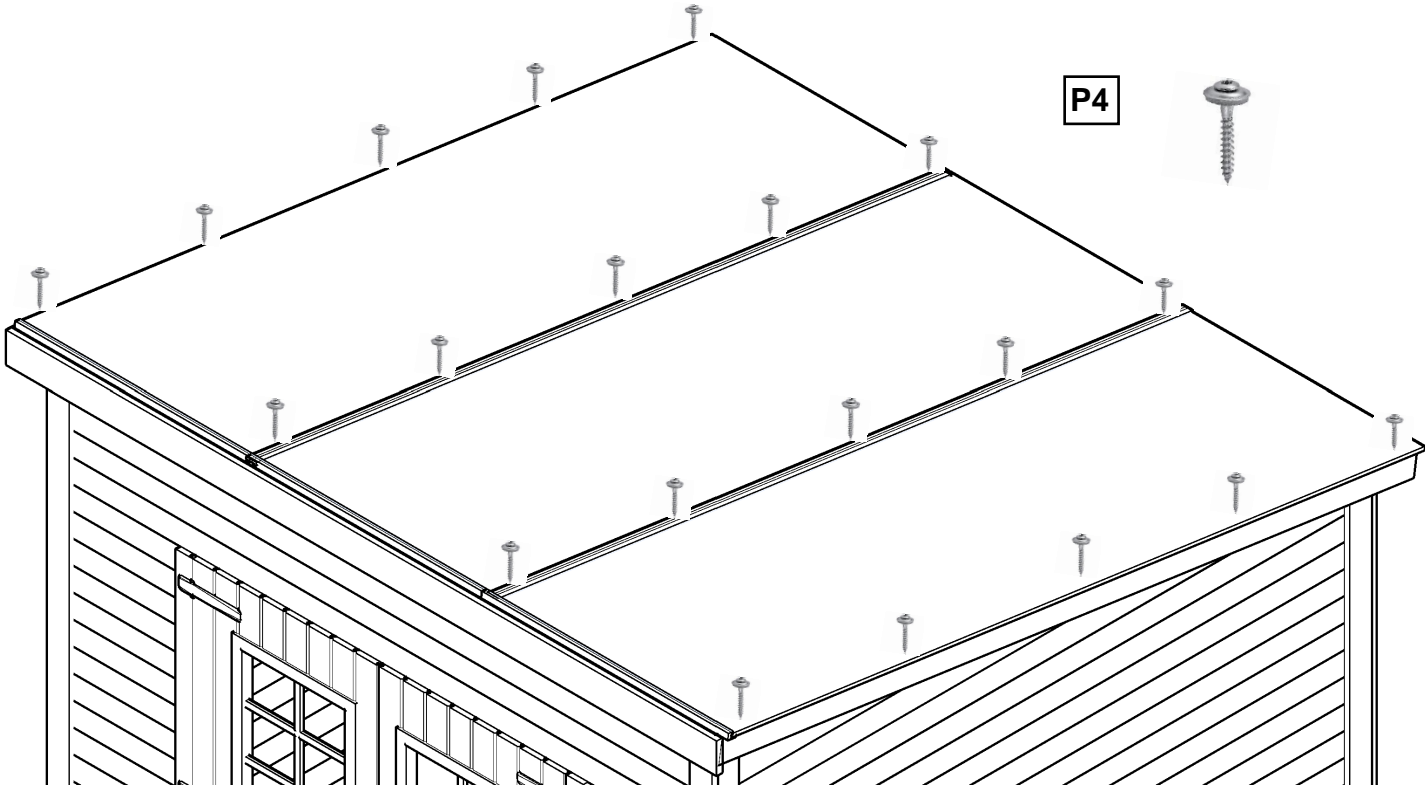
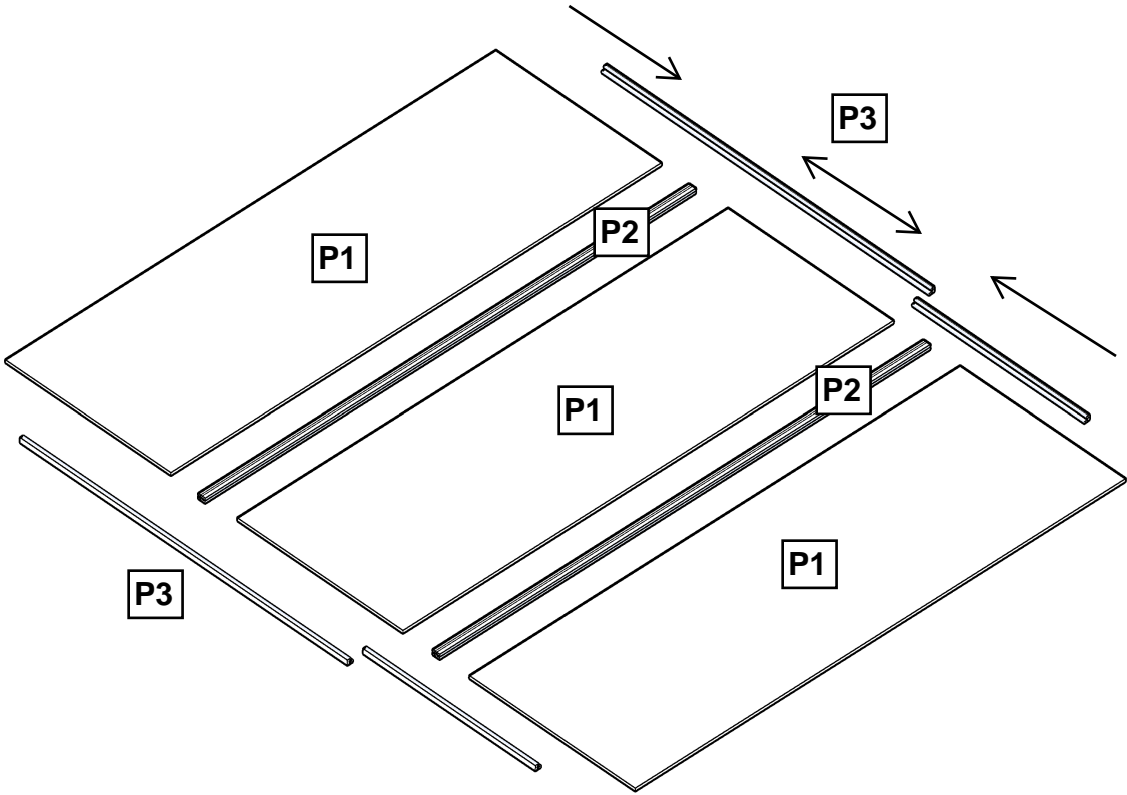

LA 3030

FIXATION CADRE PORTE

Vue extérieure

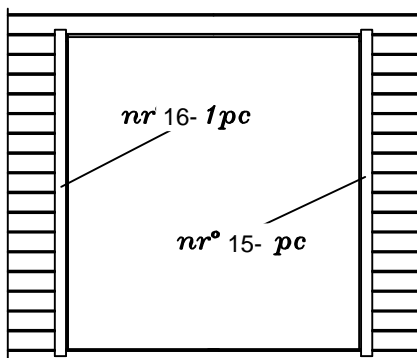

Ne pas visser les vis dans les madriers afin de les laisser travailler librement et éviter les espacements entre madriers.

Vue intérieure

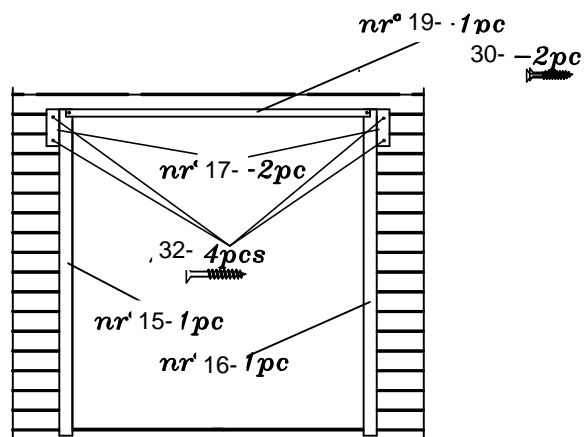

FIXATION QUINCAILLERIE ET DECORATIONS PORTE

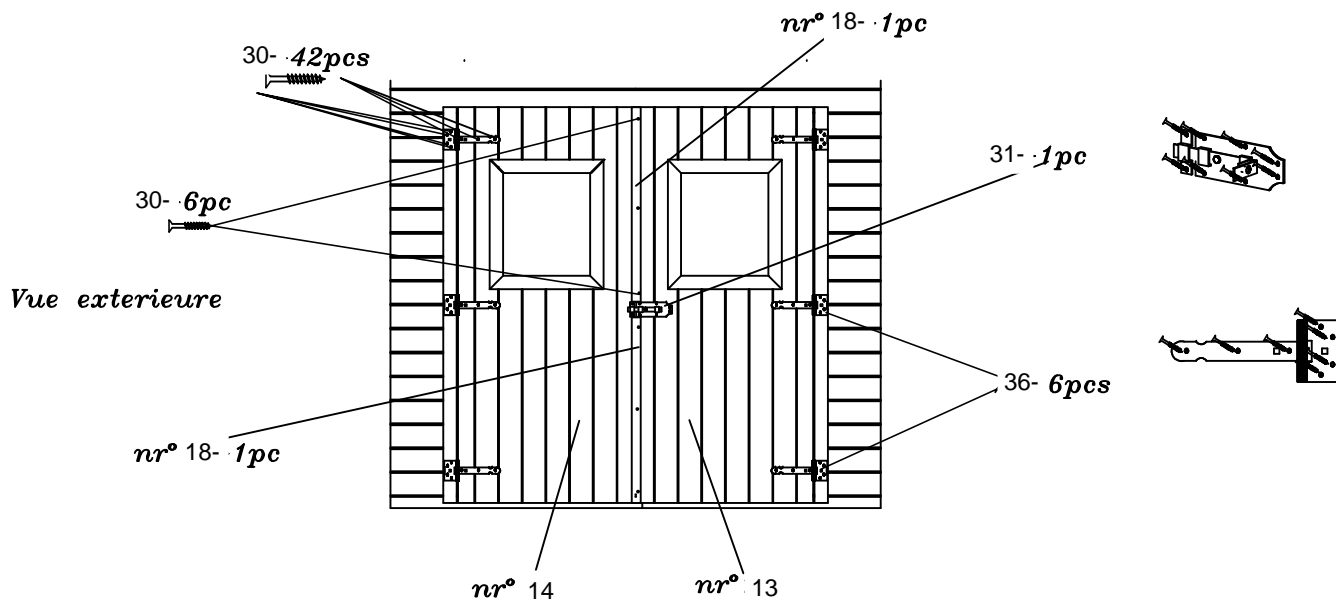

FIXATION VERROU A DOUILLE

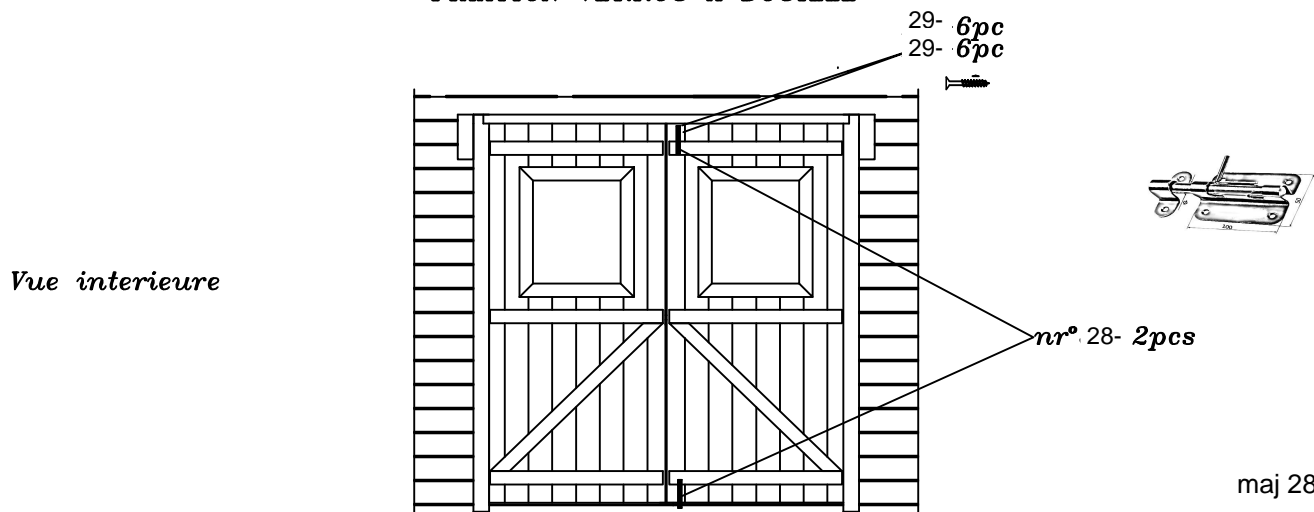

LA 3030

Paroi facade, vue de l'exterieur

1.	1	L28.0.2744d	2744*108* 28
2.	1	L28.0.2744d	2744*108* 28
3.	15+15	L28.0.527	527*108* 28
4.	5	L28.0.2744	2744*108* 28

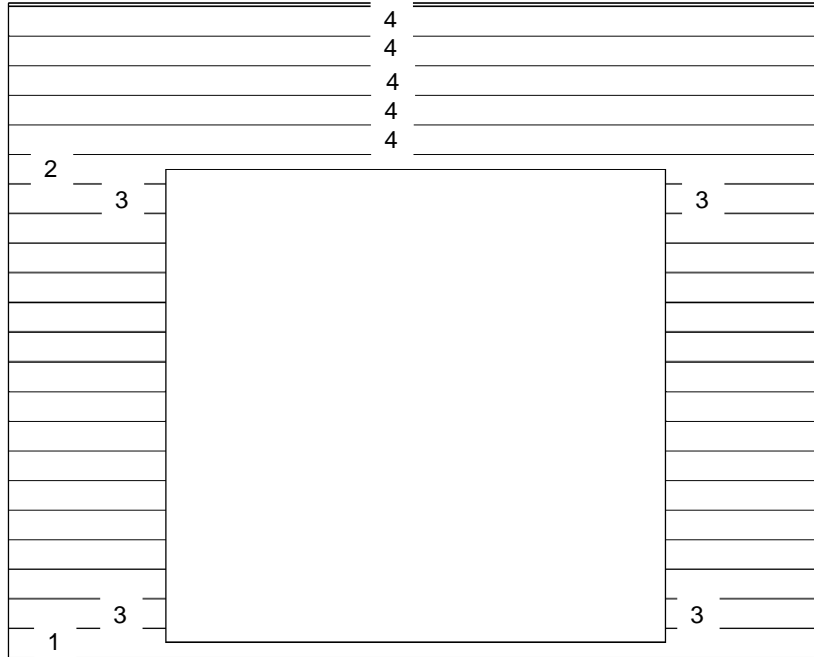

Paroi arriere, vue de l'exterieur

4.	18	L28.0.2744	2744*108* 28
----	----	------------	--------------



LA 3030

Paroi laterale, vue de l'exterieur

5.	17+17	L28.0.2744	2744*108* 28
6.	1+1	F2744.500	2744*500* 28

