

ATTENTION!!!
Pour éviter d'abîmer
vos pièces de bois, il
faut les pré-percer
avant de visser.

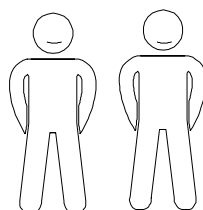
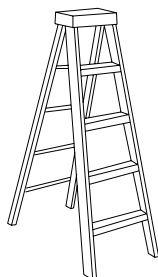

LA 3030 B

Code EAN : 3701406705403

Colis n° :
**(à rappeler impérativement pour
toute demande SAV)**

maj 28.01.2026

NOTICE DE MONTAGE
LA 3030 B

2/16

PLAN DE SOUBASSEMENT

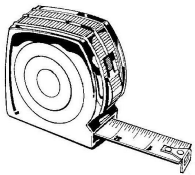
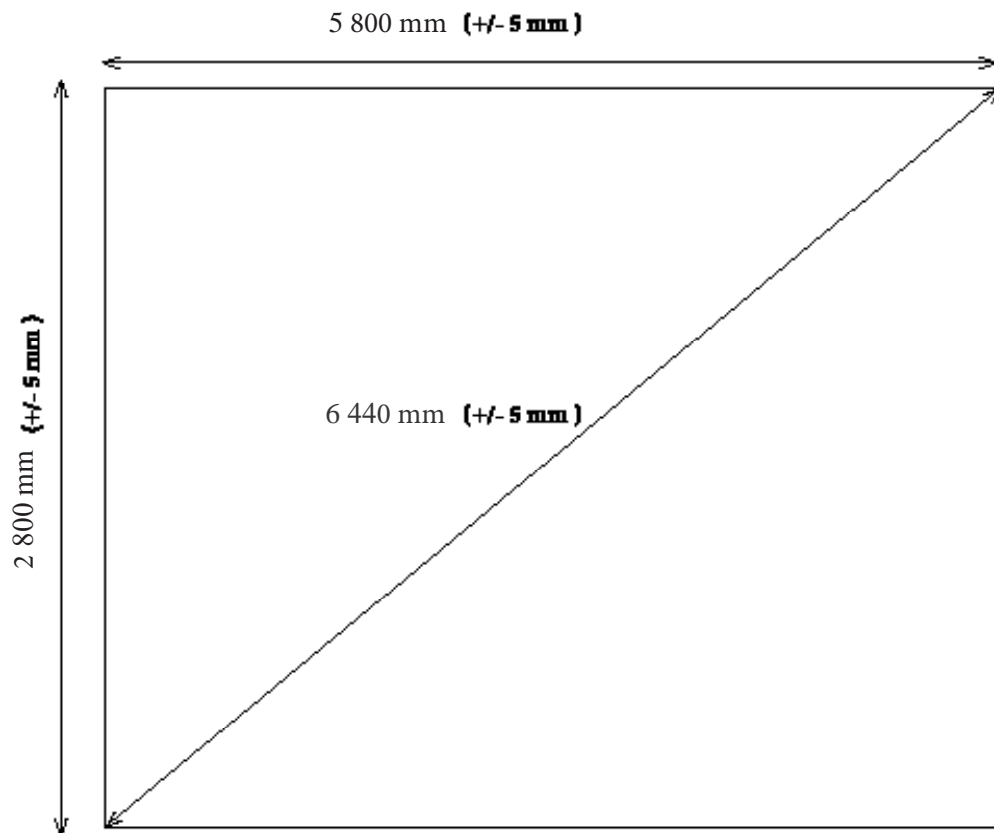









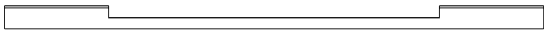





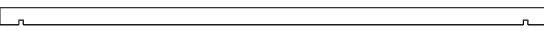
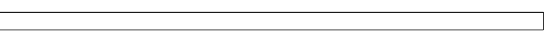

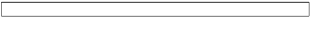

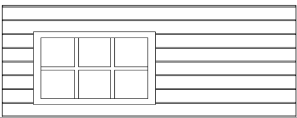
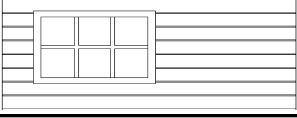
NOTICE DE MONTAGE

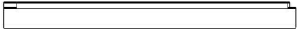
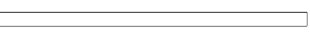
3/16

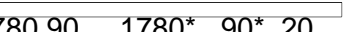
LA 3030 B

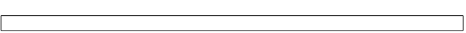
Demande SAV



Nr.	Qte	Dessin pièce	Ref	Dimensions	Observation	Qte	
1.	1		L28.0.2744d	2744*108* 28			
2.	1		L28.0.2744d	2744*108* 28			
3.	30		L28.0.527	527*108* 28			
4.	23		L28.0.2744	2744*108* 28			
5.	34		L28.0.2744	2744*108* 28			
6.	2		F2744.500	2744*500* 28 à démonter			
7.	3		P3000.90	3000* 90* 40			
8.	2		PF3000.90	3000* 90* 40			
9.	9		PD400.90	400* 90* 40			
11.	2		PF2180.70	2180* 70* 40			
12.	2		PF1780.70	1780* 70* 40			
13.	1		UD1690.48	1690*800* 48			
14.	1		US1690.48	1690*800* 48			
15.	1		TLD1690.68	1690* 80* 68			
16.	1		TLS1690.68	1690* 80* 68			
17.	2		ELT200.70	200* 70* 20			
18.	2		DP810.70	810* 70* 20			
19.	1		EST1680.40	1680* 40* 20			
20a	1	DC2180.90	2180* 90* 20	20b	1	DC2020.90	2020* 90* 20
21.	2		DC2110.90	2110* 90* 20			
22a	1	DC1780.90	1780* 90* 20	22b	1	DC1620.90	1620* 90* 20
23.	2		DC1710.90	1710* 90* 20			
24.	8		R680.20	680* 90* 20			
25.	1		DF3040.125	3040* 125* 20			
26.	2		DL3005.125	3005* 125* 20			







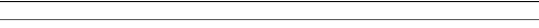

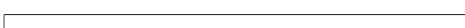
maj 28.01.2026

NOTICE DE MONTAGE

LA 3030 B

4/16

28.	1		PF2200.70	2200* 70* 80
29.	1		PF1800.70	1800* 70* 80
30.	5		PB3100.90	3100* 90* 40
31.	1		PP2820.70	2820* 70* 20
32.	1		PS2840.90	2840* 90* 40
33.	2		R680.40	680* 90* 40
34.	1		DF3000.125	3000* 125* 20

Nr.	Qte	Dessin pièce	Ref	Dimensions	Observation	Qte
35.	2		Verrou a douille			
36.	12		Vis4.0*20			
37.	75		Vis4.0*30			
38.	1		Loquet			
39.	97		Vis4.0*45			
40.	48		Vis5.0*60			
41.	320		Vis4.5*50			
42.	6		ClouL80			
43.	6		Pentures BG150			
44.	5		Equerres metalique			
45.	2		Support poteaux bucher			

A compléter impérativement pour toute demande SAV et à envoyer par mail à sav@foresta.fr + photo des pieces abimes (To be completed imperatively + Photo of damaged parts)

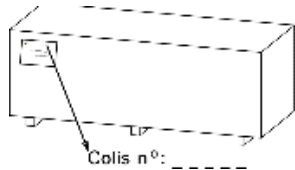
	LA 3030 B <u>Colis(package) n° :</u>	MAGASIN (STORE)	
		NOM (NAME) CLIENT	
		PRENOM(PRE.) CLIENT	
		N° de téléphone (PHONE)	

LA 3030 B

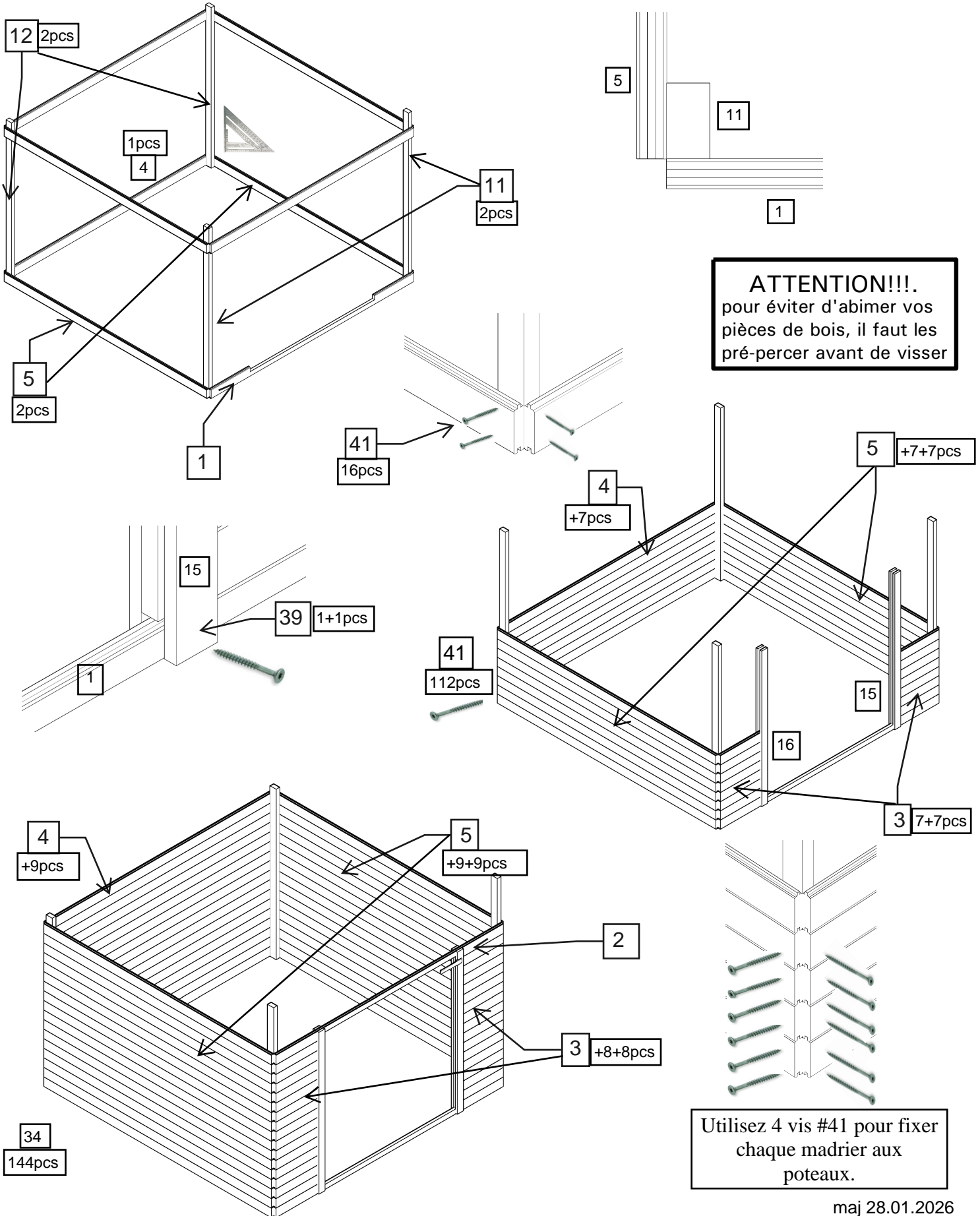

ATTENTION!!!.
 pour éviter d'abimer vos
 pièces de bois, il faut les
 pré-percer avant de visser

Utilisez 4 vis #41 pour fixer
 chaque madrier aux
 poteaux.

LA 3030 B

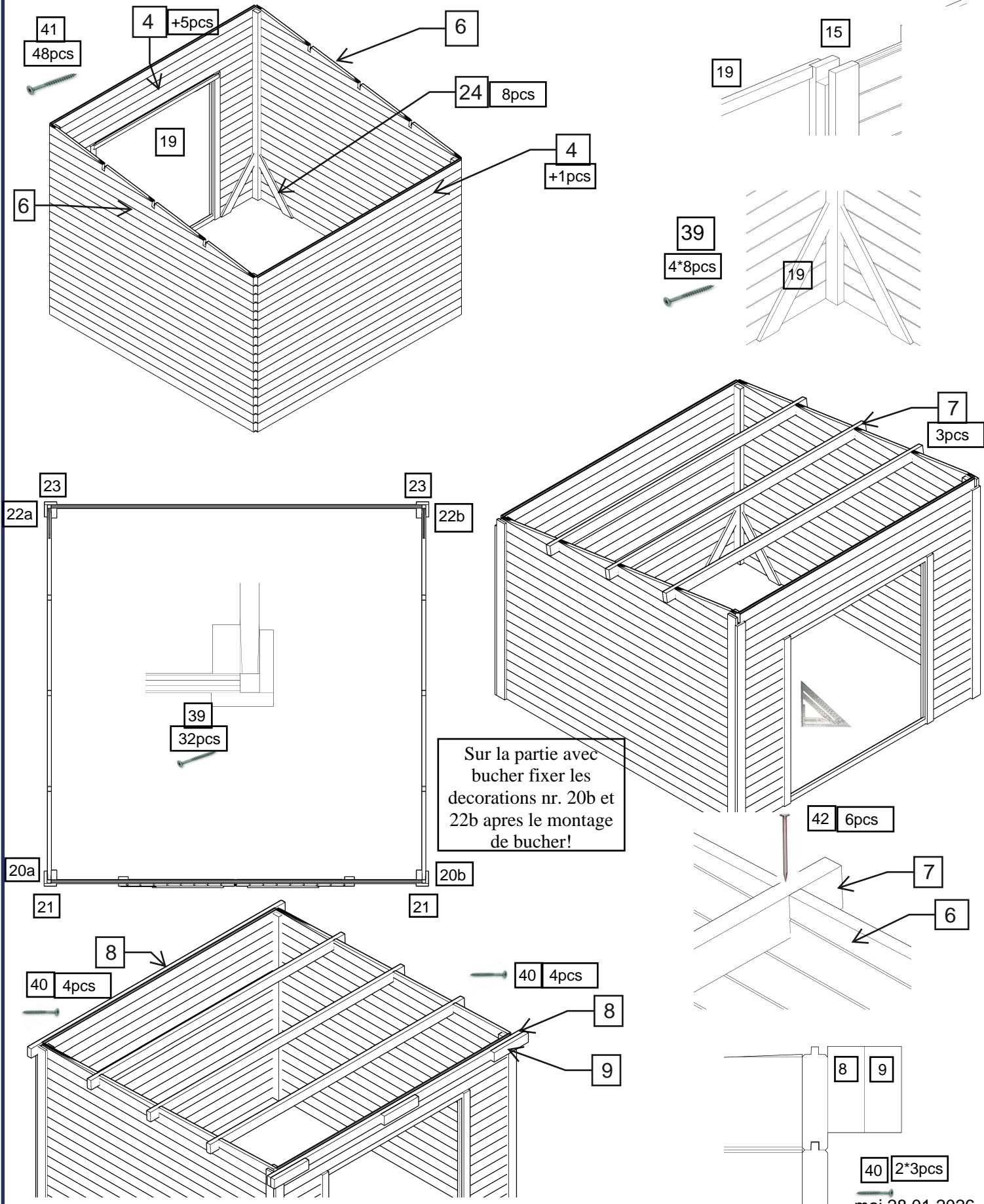

Sur la partie avec bucher fixer les decorations nr. 20b et 22b apres le montage de bucher!

NOTICE DE MONTAGE
LA 3030 B

7/16

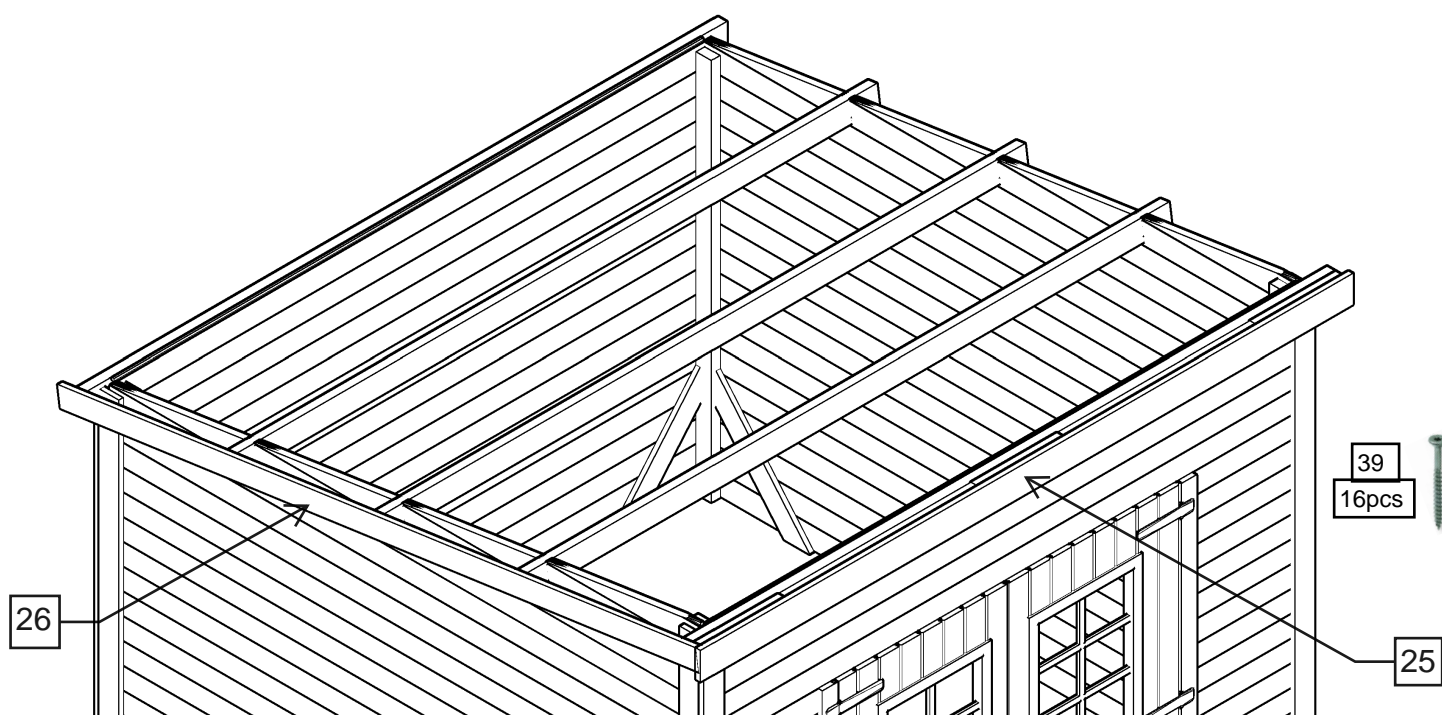

NOTICE DE MONTAGE LA 3030 B

8/16

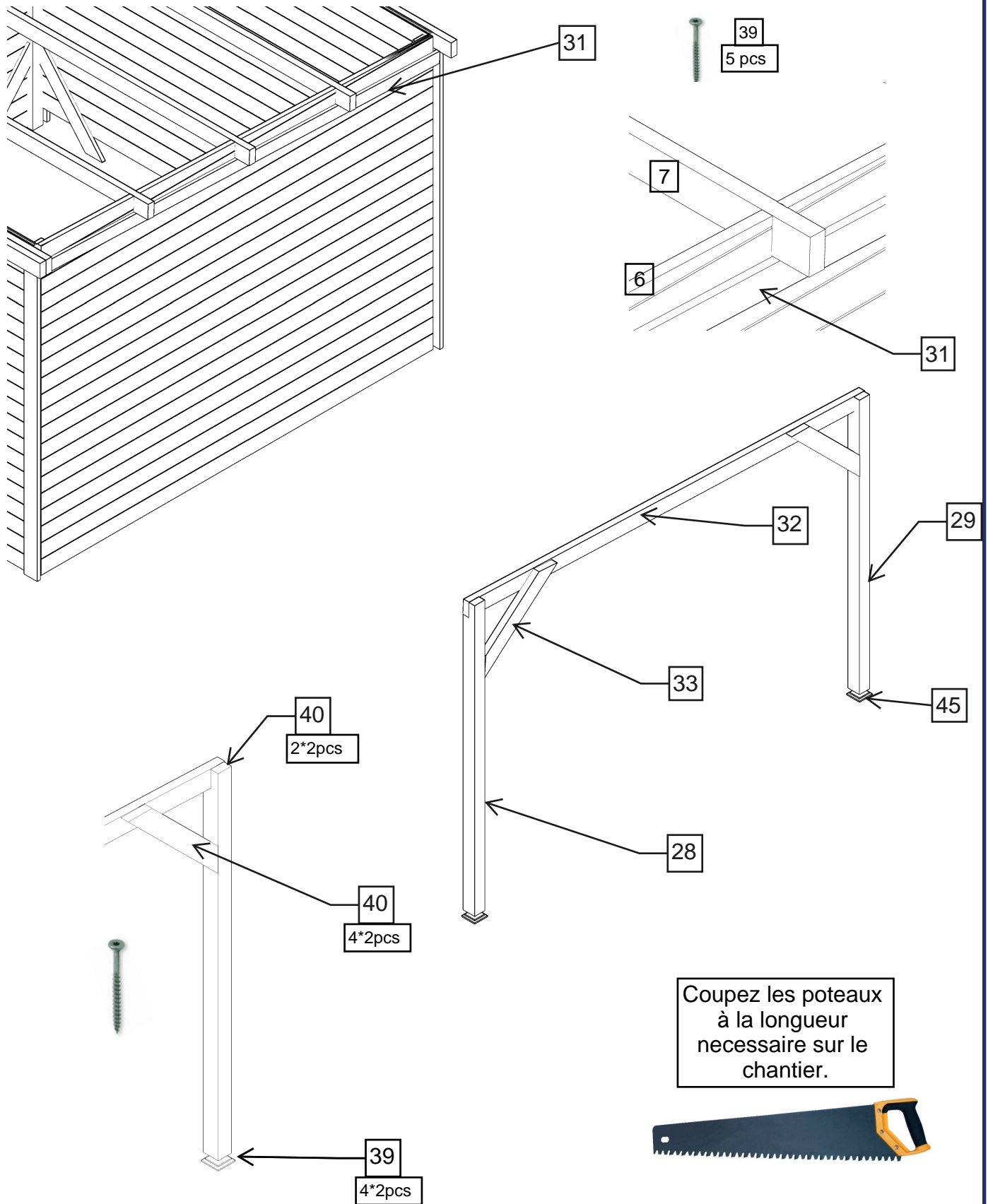

LA 3030 B

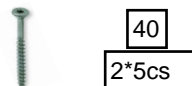
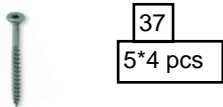
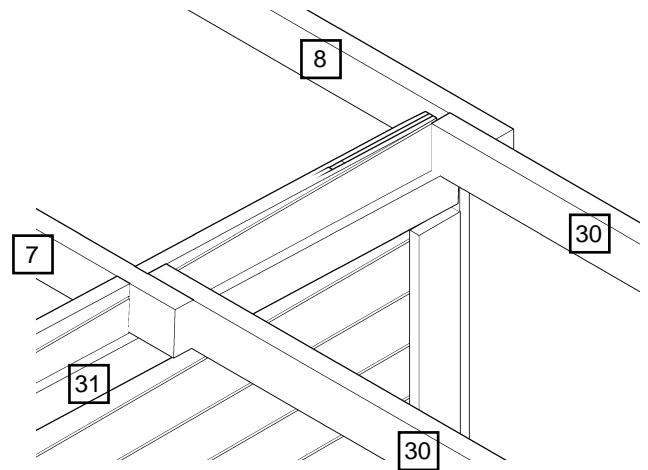
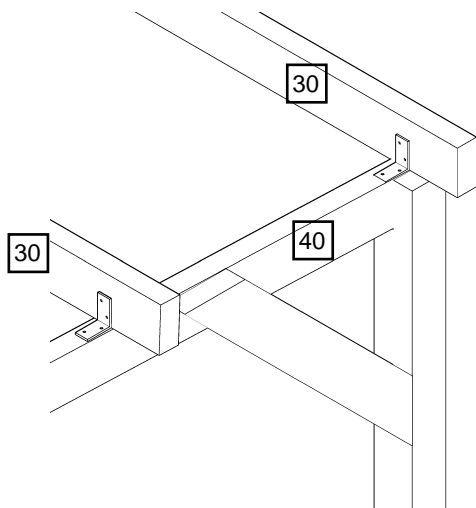
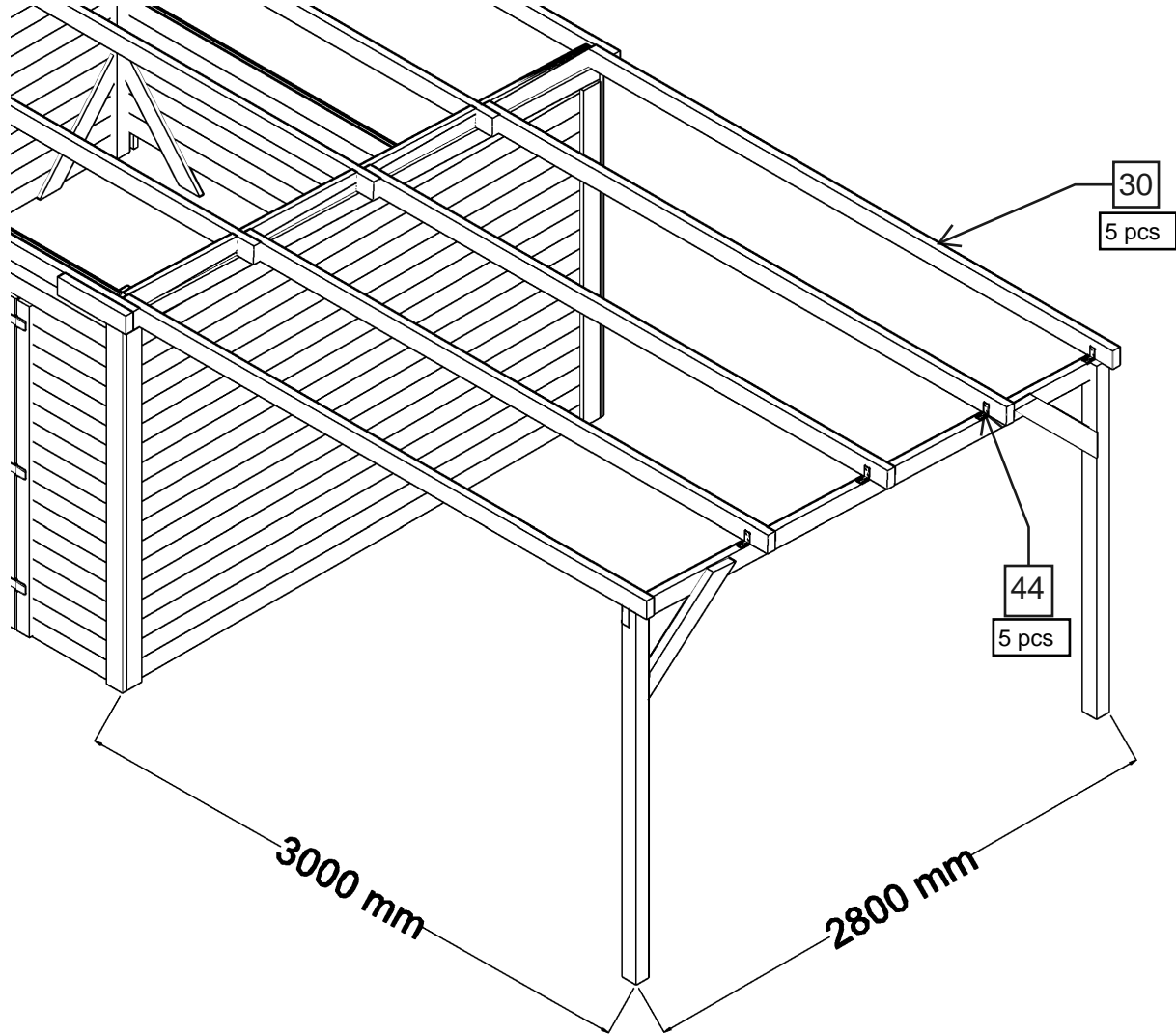

LA 3030 B

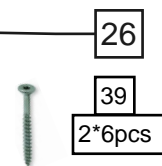
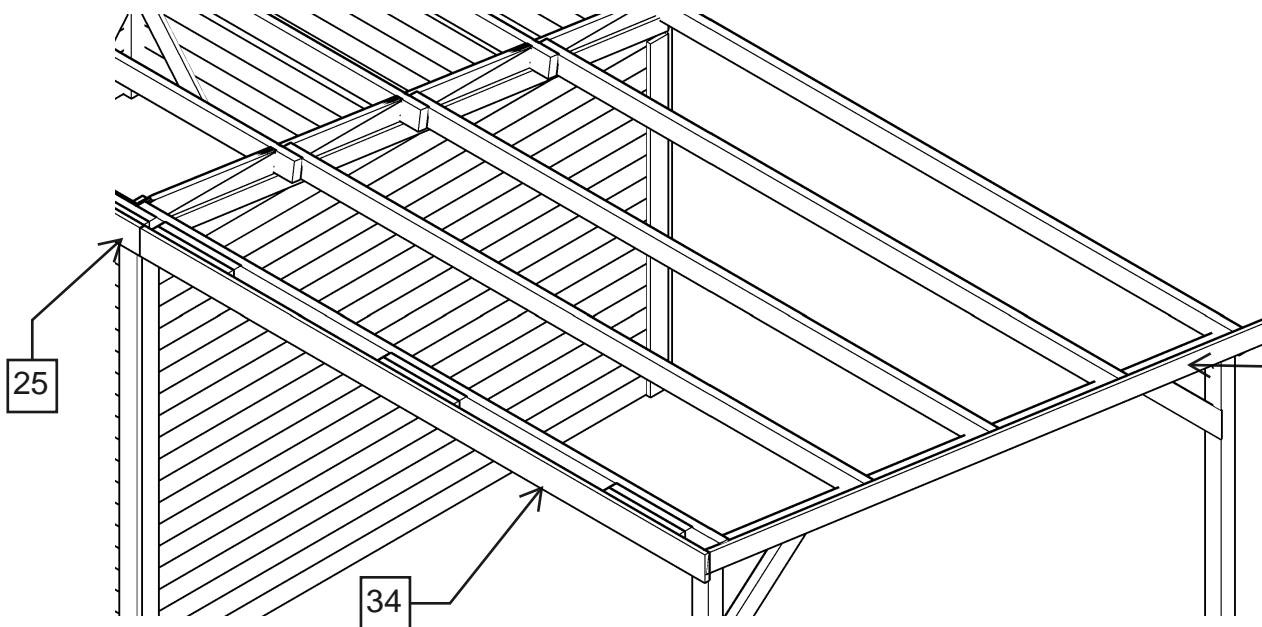
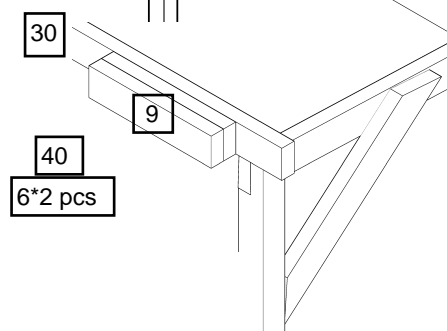
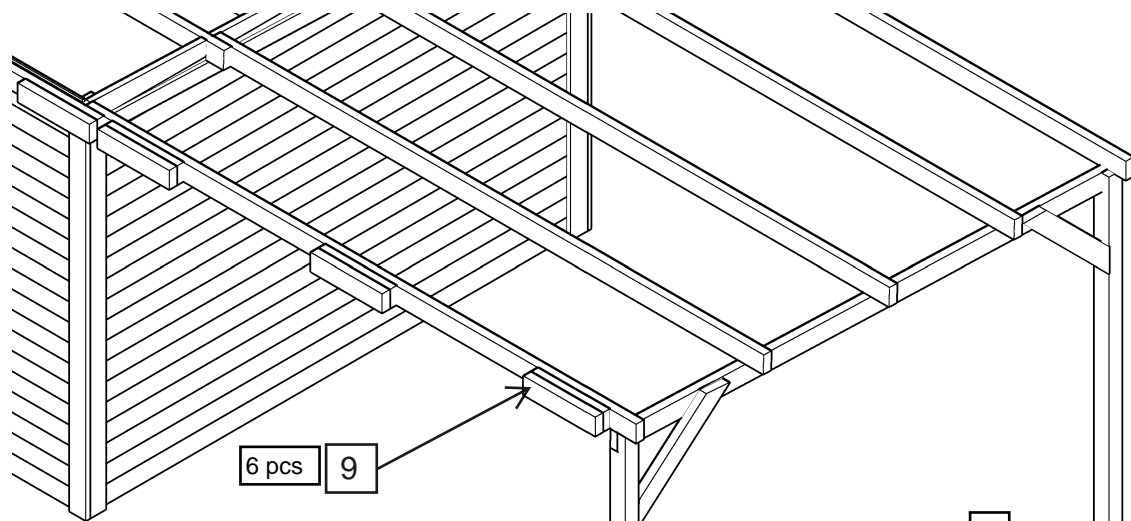



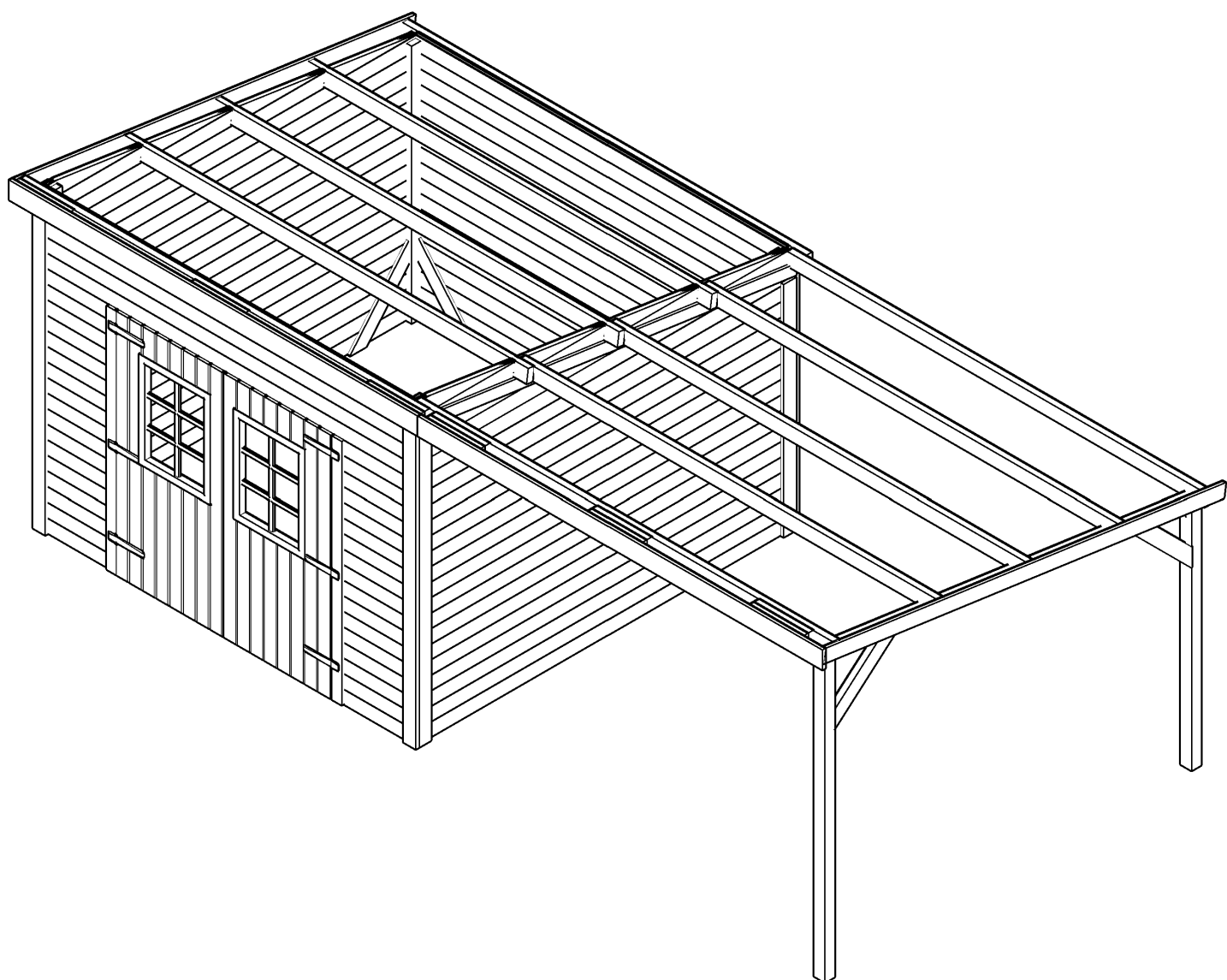

LA 3030 B

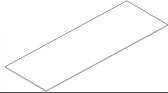

NOTICE DE MONTAGE

LA 3030 B

12/16

Nr.	Qte	Dessin pièce	Ref	Dimensions	Observation	Qte
P1.	6		POL3000.1000	3000*1000* 6		
P2.	5		PRH3000	3000* 30* 6		
P3.	6		PRU2000	2000* 20* 6		
P4.	35		VIS	4,5 * 25		

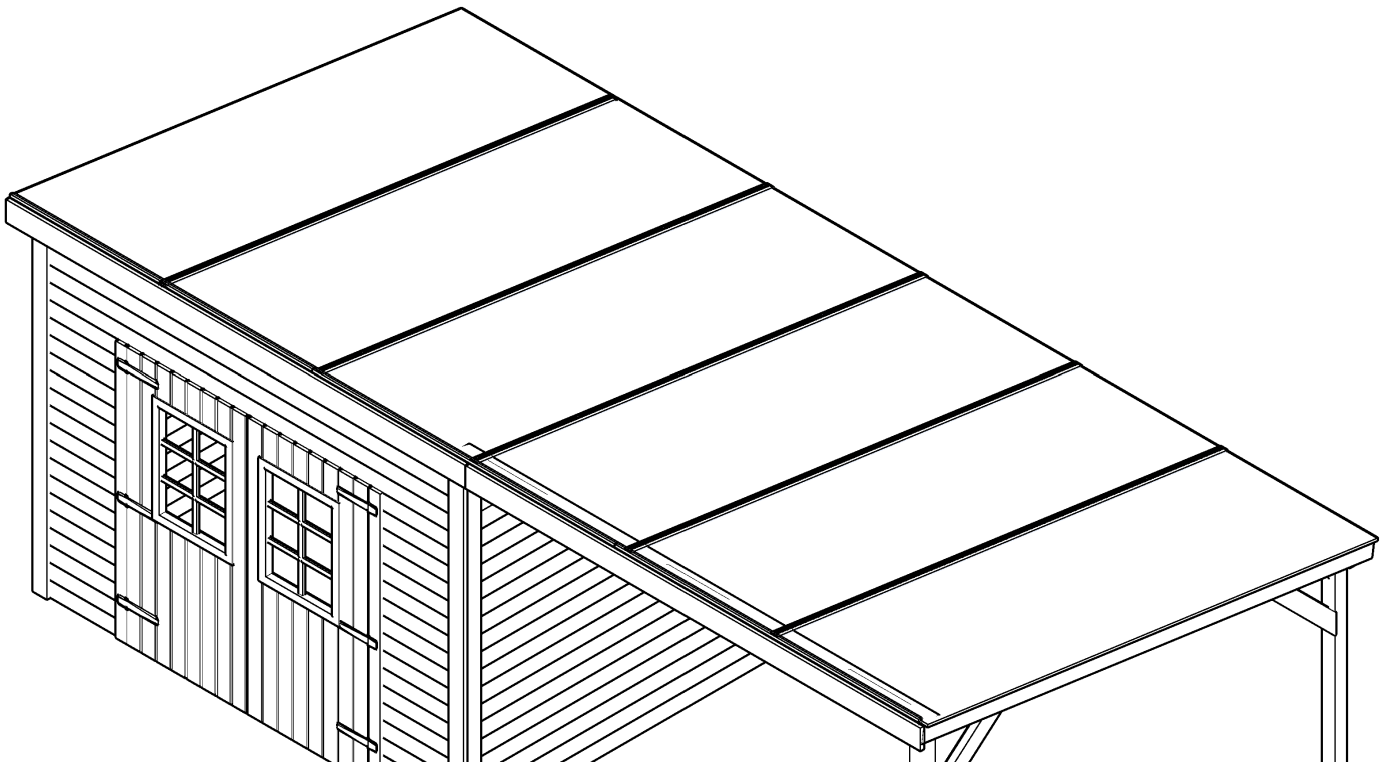

À l'aide d'un cutter, découpez une feuille de polycarbonate à une largeur de 710 mm.

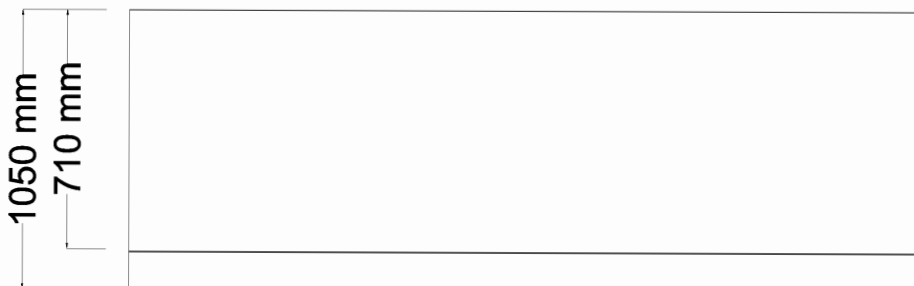

LA 3030 B

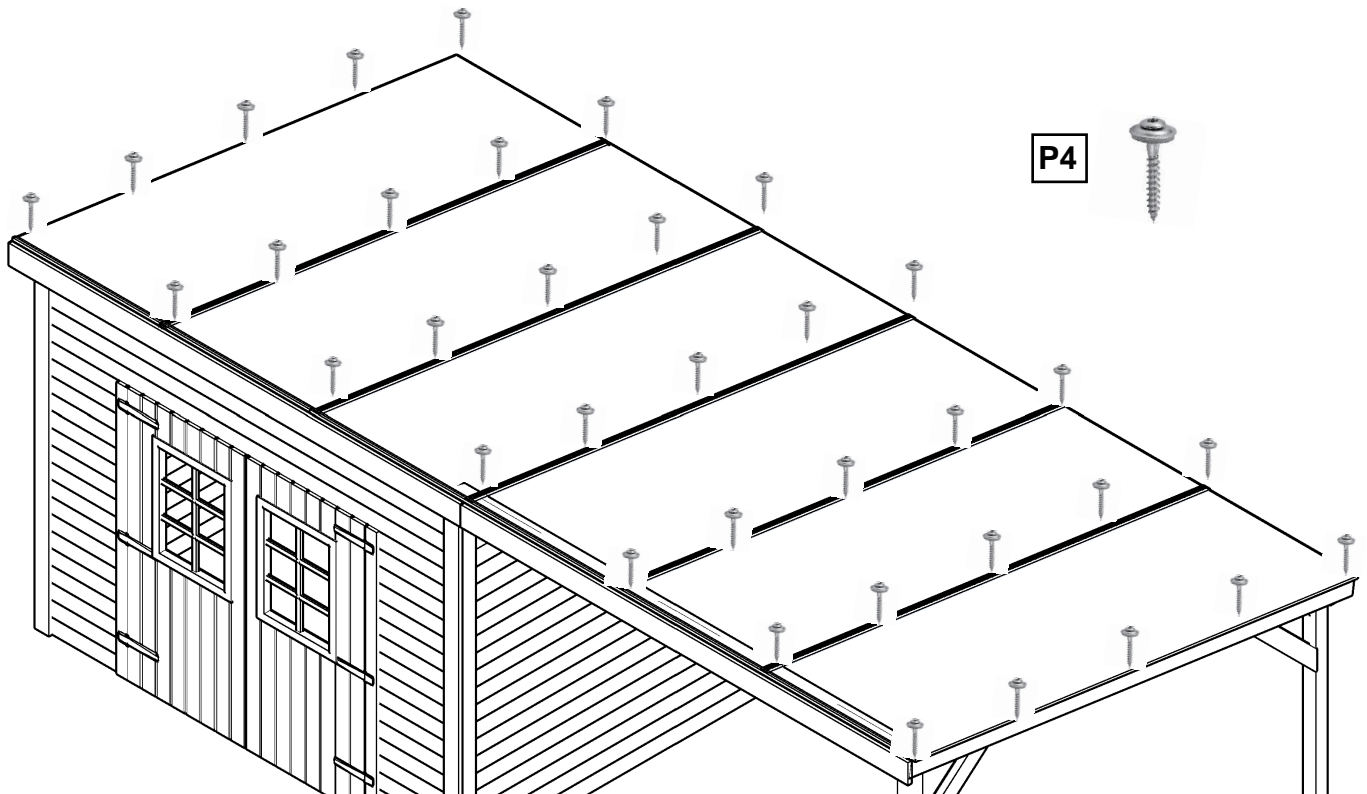
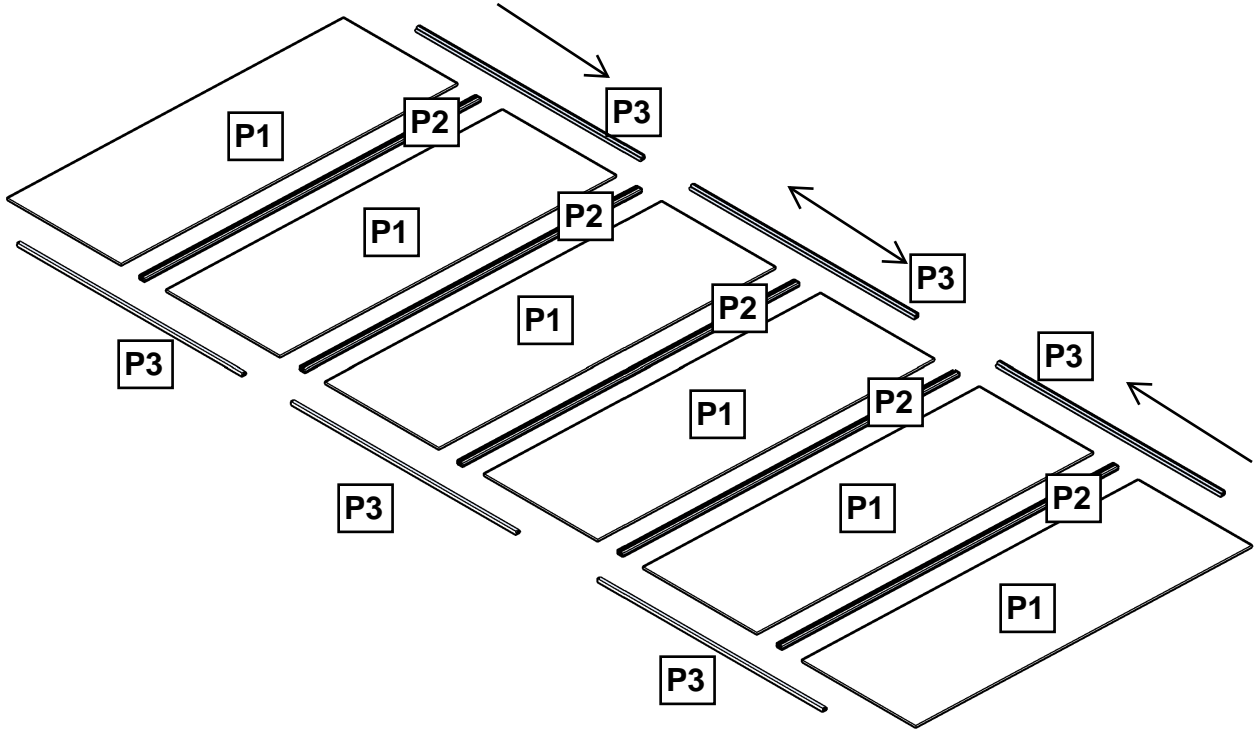

LA 3030 B

FIXATION CADRE PORTE

Vue extérieure

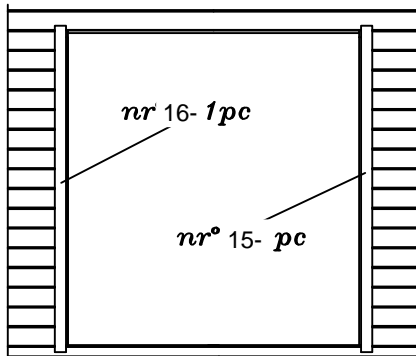

Ne pas visser les vis dans les madriers afin de les laisser travailler librement et éviter les espacements entre madriers.

Vue intérieure

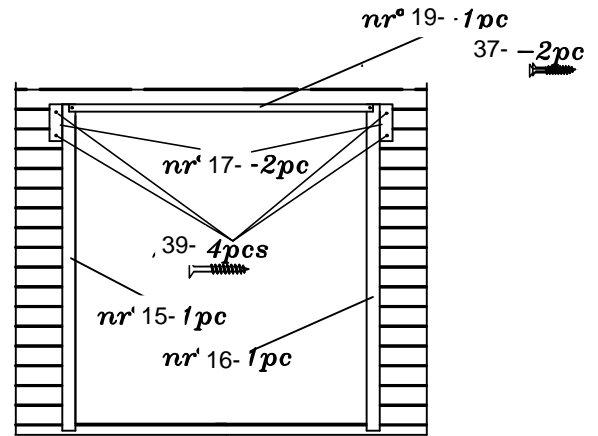

FIXATION QUINCAILLERIE ET DECORATIONS PORTE

Vue extérieure

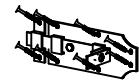
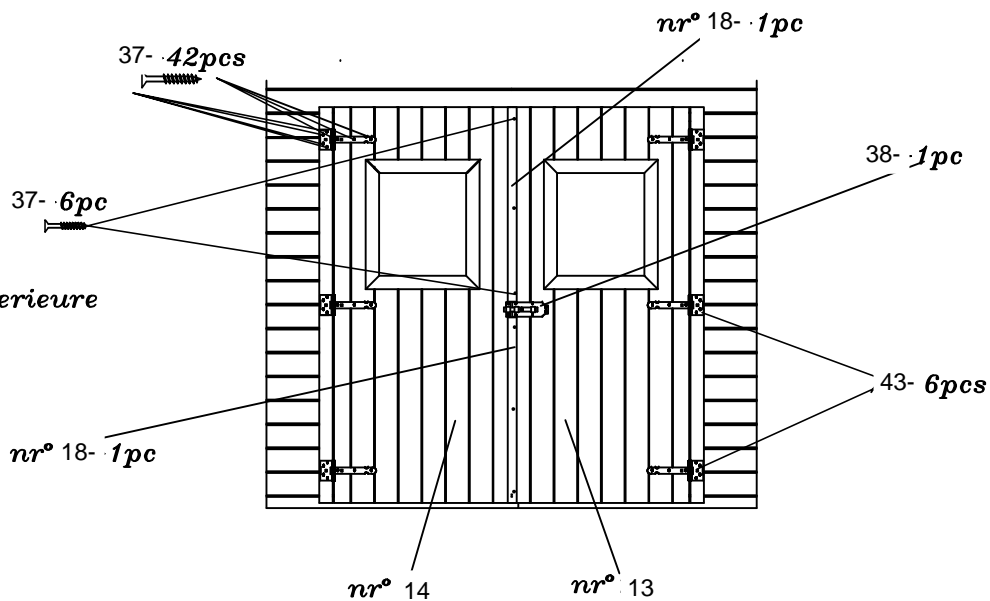

FIXATION VERROU A DOUILLE

Vue intérieure

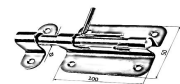
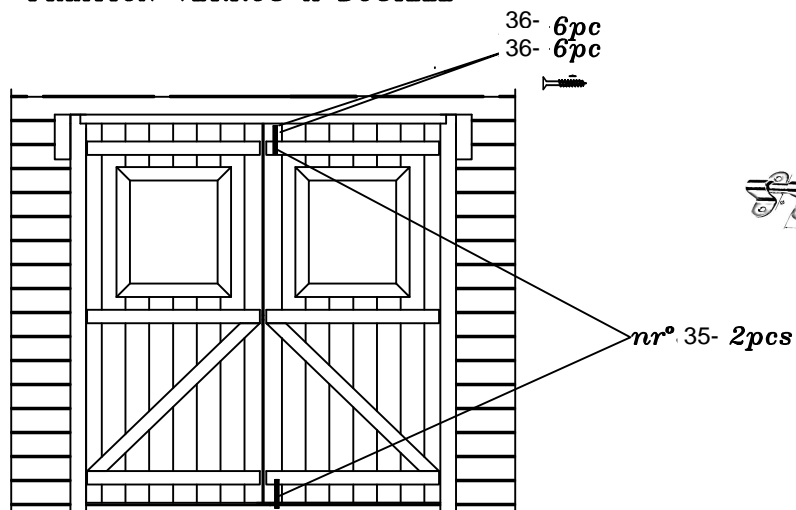

LA 3030 B

Paroi facade, vue de l'exterieur

1.	1	L28.0.2744d	2744*108* 28
2.	1	L28.0.2744d	2744*108* 28
3.	15+15	L28.0.527	527*108* 28
4.	5	L28.0.2744	2744*108* 28

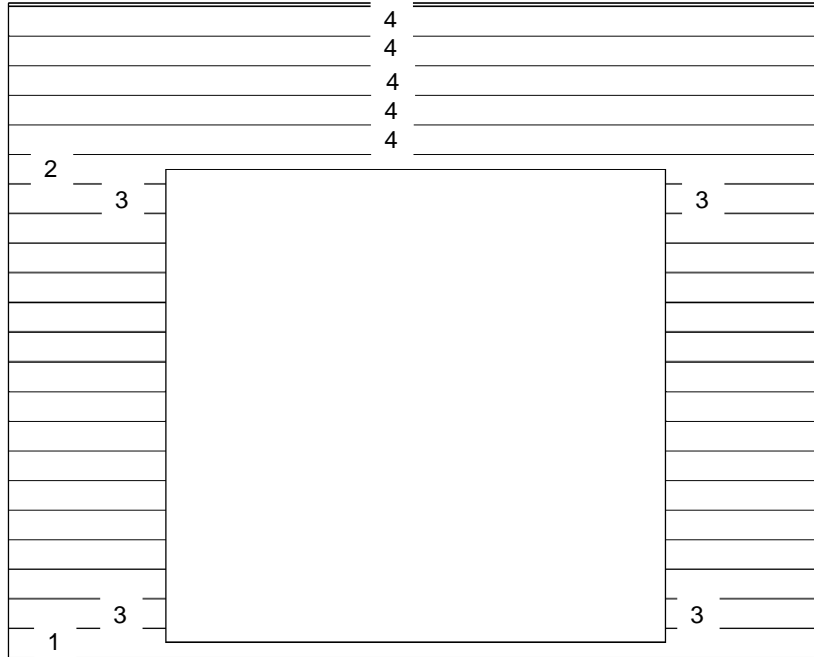

Paroi arriere, vue de l'exterieur

4.	18	L28.0.2744	2744*108* 28
----	----	------------	--------------

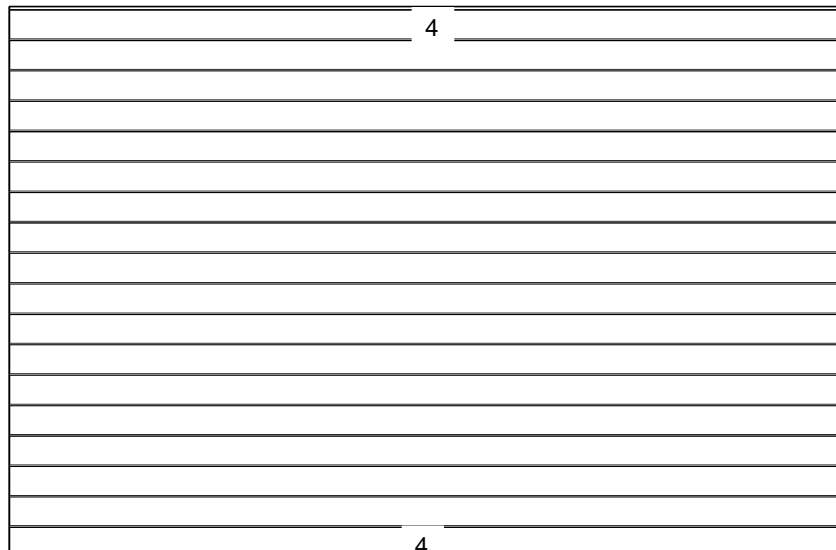

LA 3030 B

Paroi laterale, vue de l'exterieur

5.	17+17	L28.0.2744	2744*108* 28
6.	1+1	F2744.500	2744*500* 28

