

ATTENTION!!!
Pour éviter d'abîmer
vos pièces de bois, il
faut les pré-percer
avant de visser.

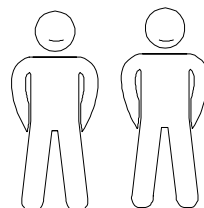
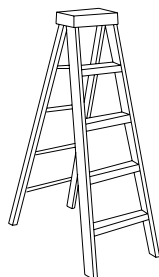

LA 4030

Code EAN : 3701406705410

Colis n° :
(à rappeler impérativement pour
toute demande SAV)

maj 28.01.2026

PLAN DE SOUBASSEMENT

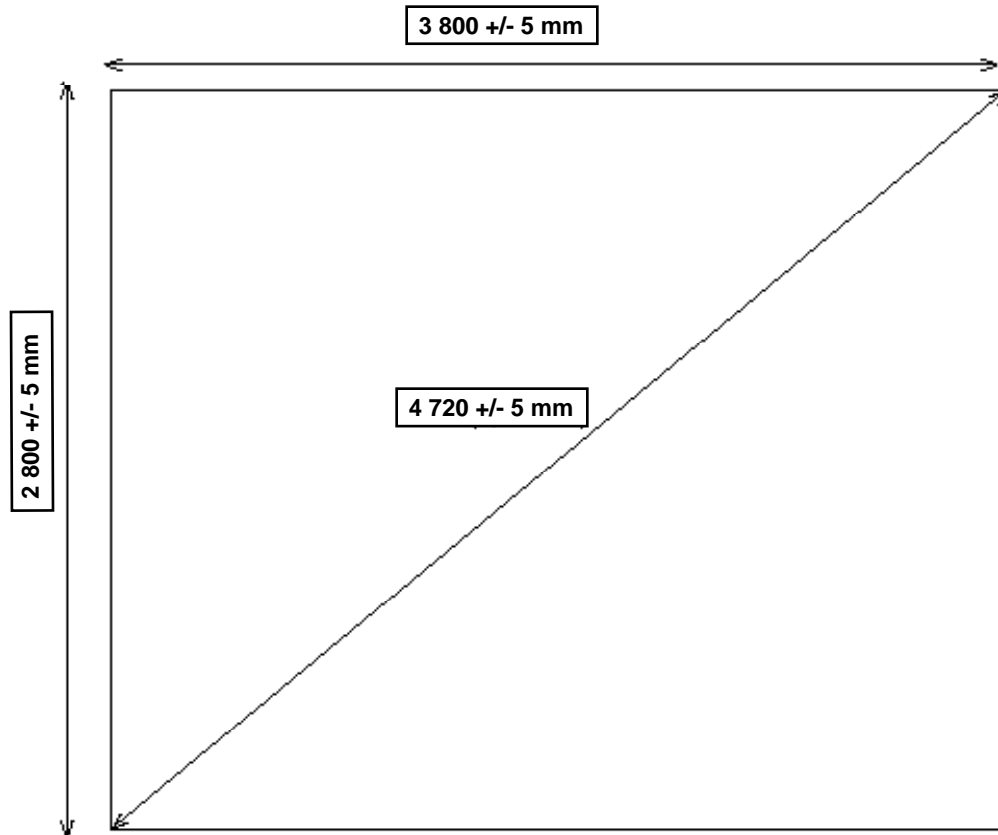

Les dimensions données sur le plan de soubassement sont les dimensions

de la dalle béton à réaliser sur un sol parfaitement plat sans aucun autre objet extérieur type mur, clôture ou arbre dans l'entourage de la dalle.

Si le produit est implanté près d'un mur, d'une haie ou d'un arbre il est nécessaire de l'éloigner des éléments extérieurs afin de pouvoir facilement le monter et l'entretenir. Nous nous dégageons de toute responsabilité en cas de mauvaise interprétation des dimensions de la dalle.

Le dimensioni del piano di base sono le dimensioni della soletta di cemento da realizzare su un terreno perfettamente piatto, senza alcun altro oggetto esterno, come un muro, una recinzione o un albero in prossimità delle soletta. Se il prodotto è installato vicino ad una parete, un recinto o un albero, è necessario distanziarlo adeguatamente, in modo da poterlo facilmente montare e farne la manutenzione. Non ci assumiamo alcuna responsabilità per l'errata interpretazione delle dimensioni delle lastra.

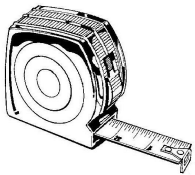

Tolérances à respecter (selon DTU 31.2):











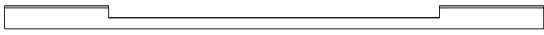





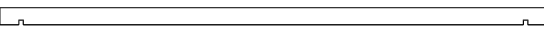
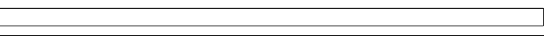

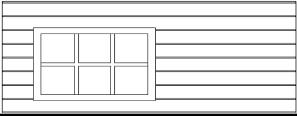
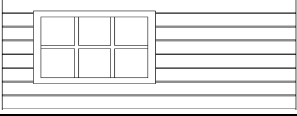
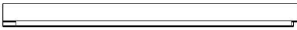
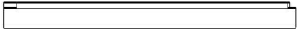

- longueur et largeur: + 0,01m;
- équerage: +0,01m mesuré sur 10m;
- arase: +0,01m sur une longueur de 10 mètres linéaires alignés ou non et de + 2mm par mètre linéaire;
- rectitude de bords en plan: +5mm .

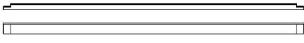
NOTICE DE MONTAGE

3/13

LA 4030

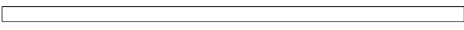
Demande SAV

Nr.	Qte	Dessin pièce	Ref	Dimensions	Observation	Qte
1.	1		L28.0.3744d	3744*108* 28		
2.	1		L28.0.3744d	3744*108* 28		
3.	14		L28.0.1027	1027*108* 28		
4.	23		L28.0.3744	3744*108* 28		
5.	34		L28.0.2744	2744*108* 28		
6.	2		F2744.500	2744*500* 28 à démonter		
7.	3		P4000.125	4000*125* 40		
8.	2		PF4000.90	4000* 90* 40		
9.	3		PD400.90	400* 90* 40		
11.	2		PF2180.70	2180* 70* 40		
12.	2		PF1780.70	1780* 70* 40		
13.	1		UD1690.48	1690*800* 48		
14.	1		US1690.48	1690*800* 48		
15.	1		TLD1690.68	1690* 80* 68		
16.	1		TLS1690.68	1690* 80* 68		
17.	2		ELT200.70	200* 70* 20		
18.	2		DP810.70	810* 70* 20		
19.	1		EST1680.40	1680* 40* 20		
20.	2		DC2180.90	2180* 90* 20		
21.	2		DC2110.90	2110* 90* 20		
22.	2		DC1780.90	1780* 90* 20		
23.	2		DC1710.90	1710* 90* 20		
24.	8		R680.20	680* 90* 20		
25.	2		DF2020.125	2020* 125* 20		
26.	2		DL3005.90	3005* 90* 20		







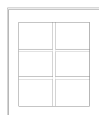

maj 28.01.2026

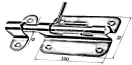
NOTICE DE MONTAGE

LA 4030

4/13

28.	32		L28.0.228	228* 108* 28
29.	2		FF770.640.28	770* 640* 68

Nr.	Qte	Dessin pièce	Ref	Dimensions	Observation	Qte
30.	2		Verrou a douille			
31.	12		Vis4.0*20			
32.	58		Vis4.0*30			
33.	1		Loquet			
34.	99		Vis4.0*45			
35.	14		Vis5.0*60			
36.	320		Vis4.5*50			
37.	6		ClouL80			
38.	6		Pentures BG150			

**A compléter impérativement pour toute demande SAV et à envoyer par mail à
+ photo des pièces abimées (To be completed imperatively + Photo of damaged parts)**

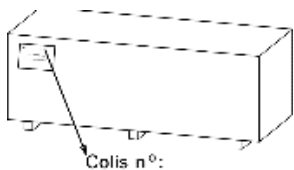
	LA 480 Colis(package) n° :	MAGASIN (STORE)	
		NOM (NAME) CLIENT	
		PRENOM(PRE.) CLIENT	
		N° de téléphone (PHONE)	

LA 4030

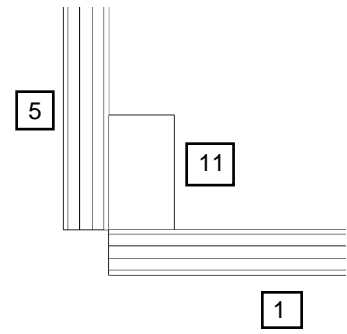
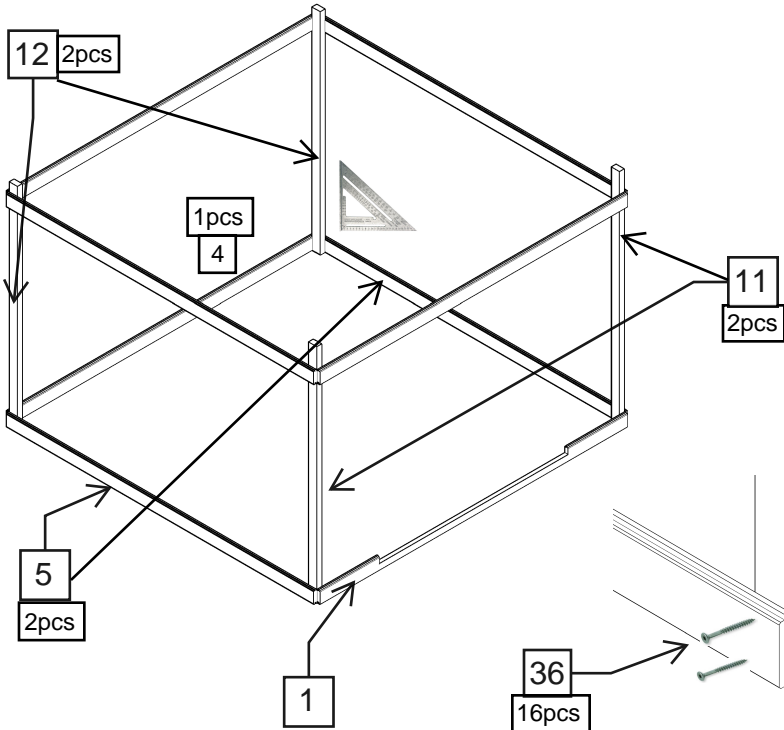

ATTENTION!!!.
pour éviter d'abimer vos
pièces de bois, il faut les
pré-percer avant de visser

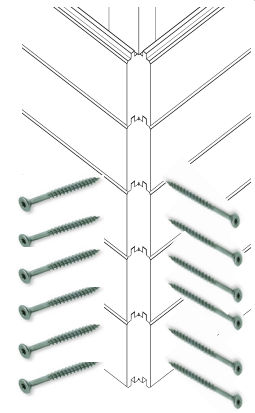
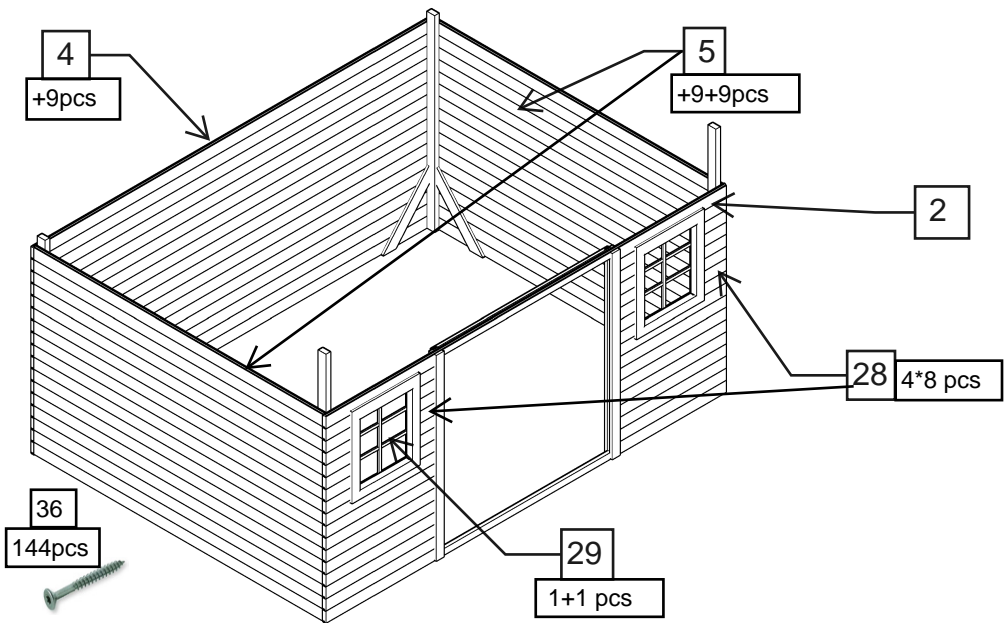
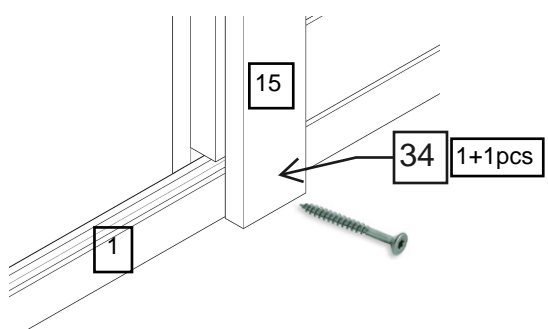
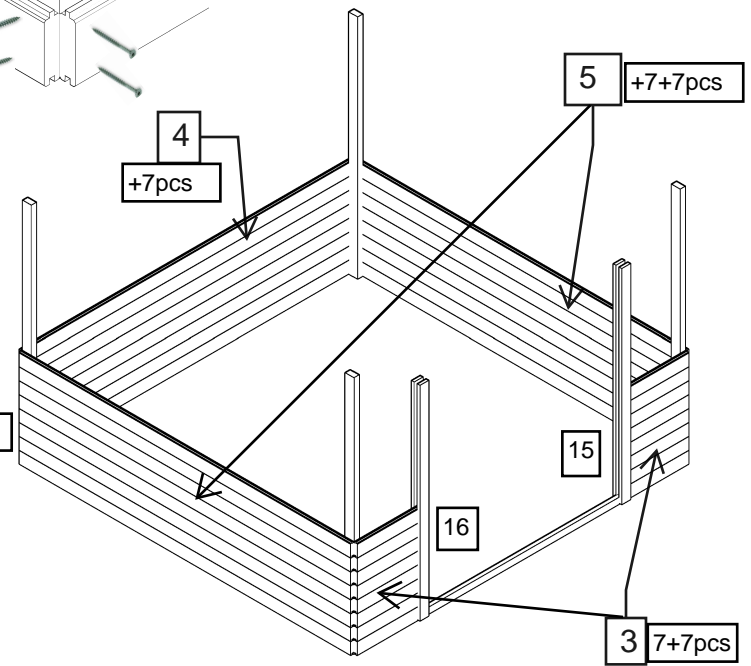
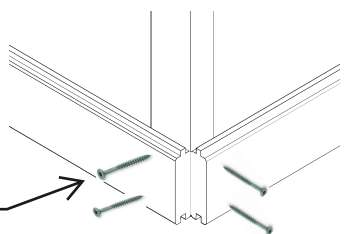

Utilisez 4 vis #36 pour fixer
chaque madrier aux
poteaux.

NOTICE DE MONTAGE

LA 4030

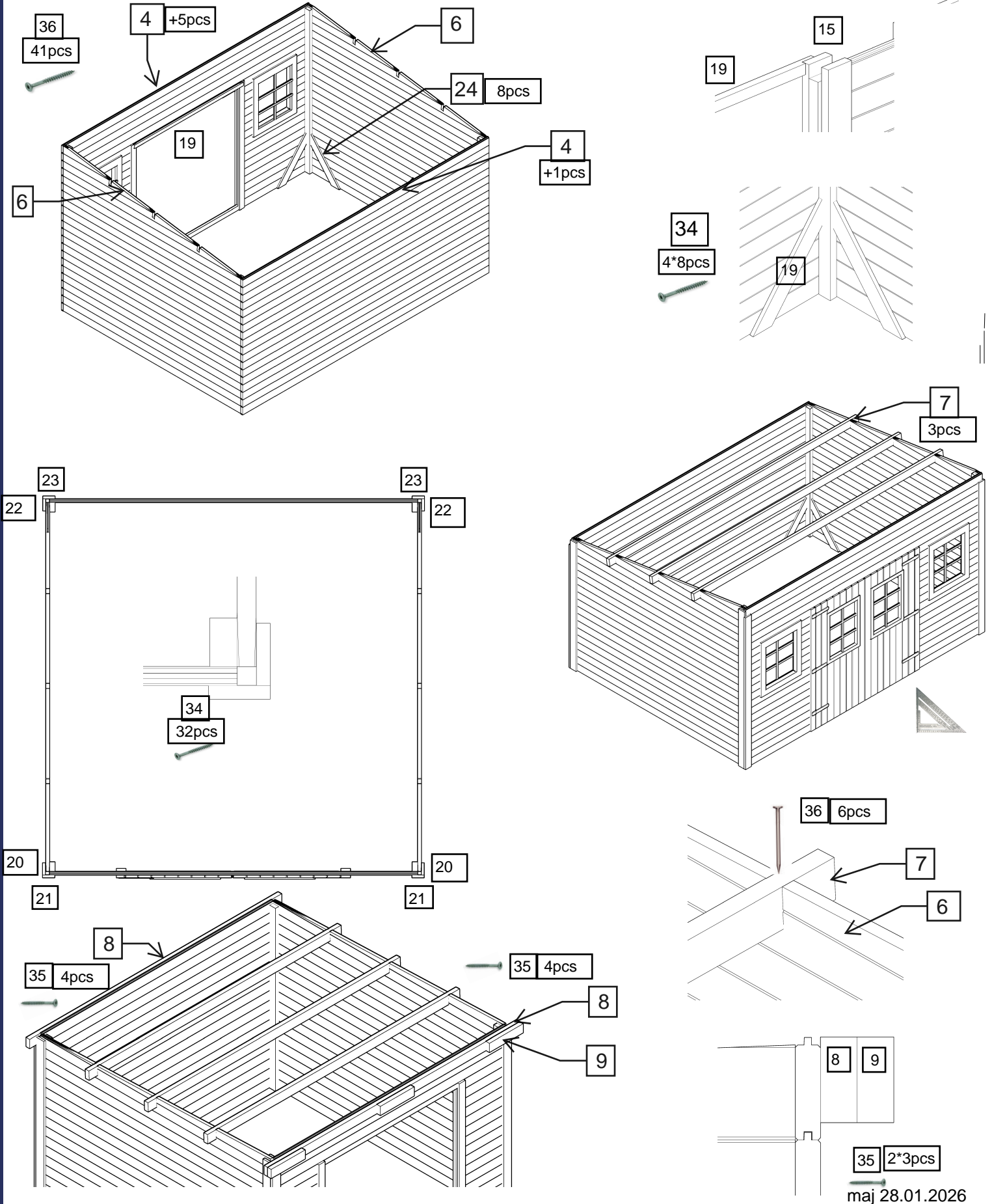

NOTICE DE MONTAGE
LA 4030

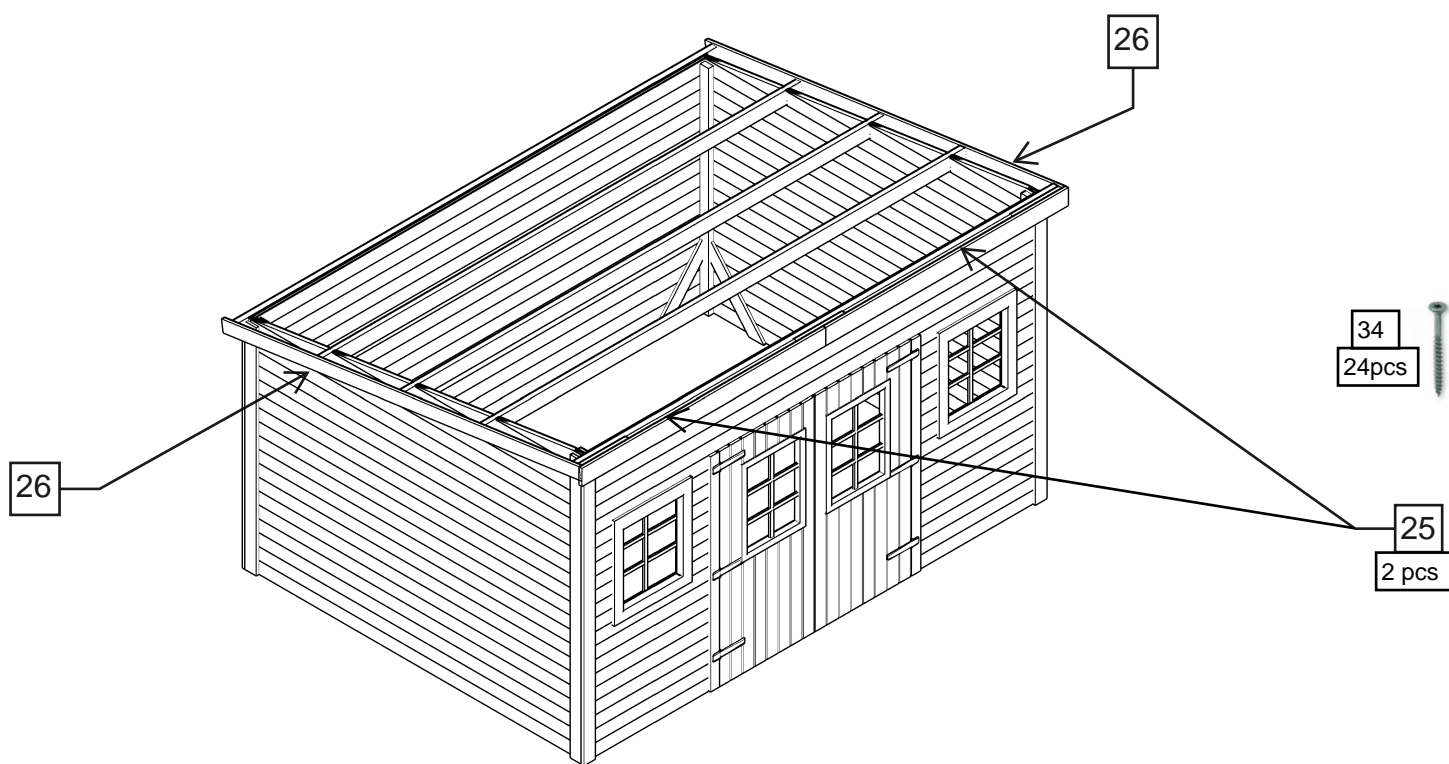



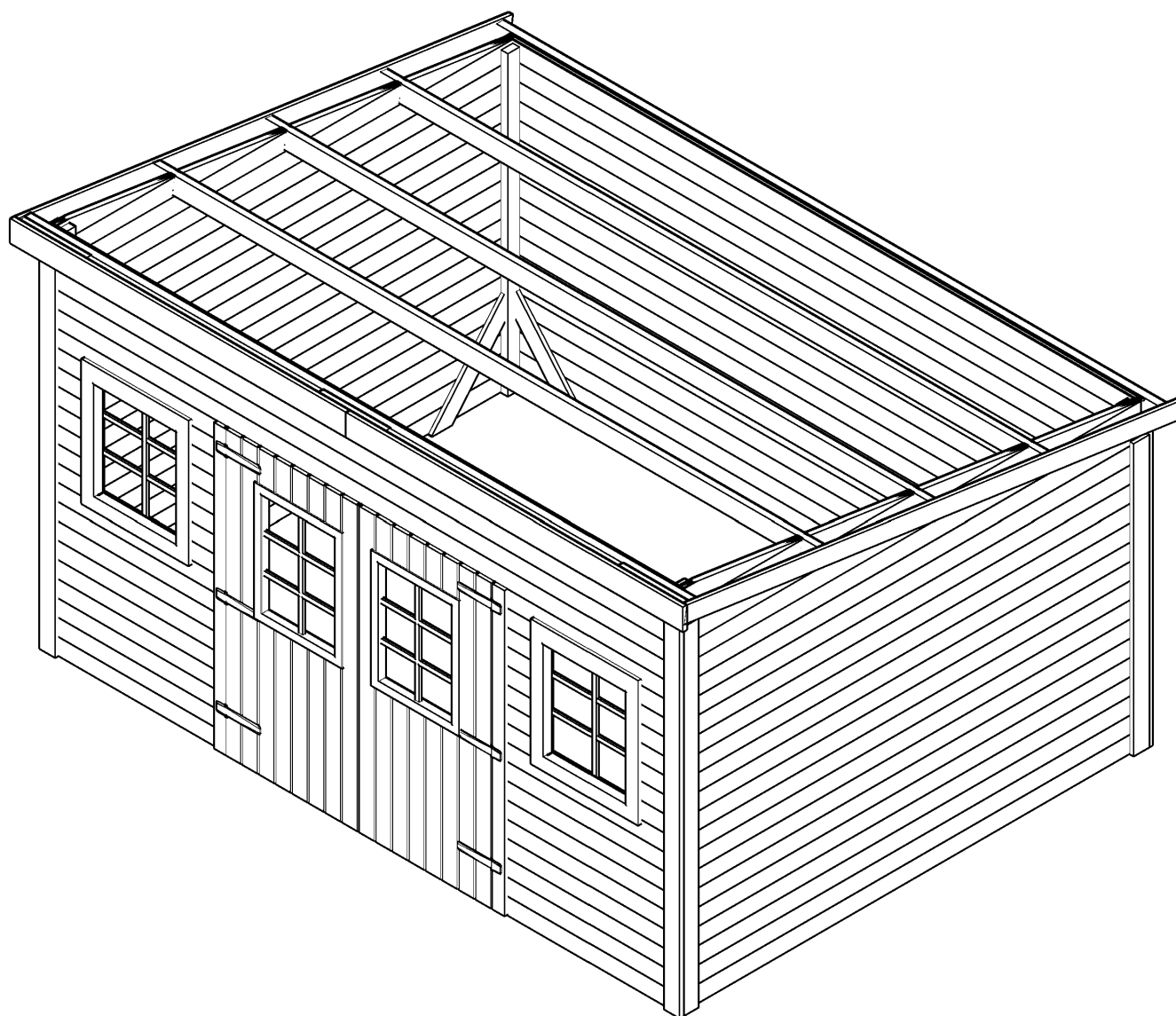



LA 4030

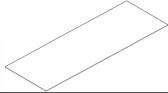

NOTICE DE MONTAGE

9/13

LA 4030

Nr. Qte	Dessin pièce	Ref	Dimensions	Observation	Qte
P1. 4		POL3000.1000	3000*1000* 6		
P2. 3	 	PRH3000	3000* 30* 6		
P3. 4	 	PRU2000	2000* 20* 6		
P4. 25		VIS	4,5 * 25		

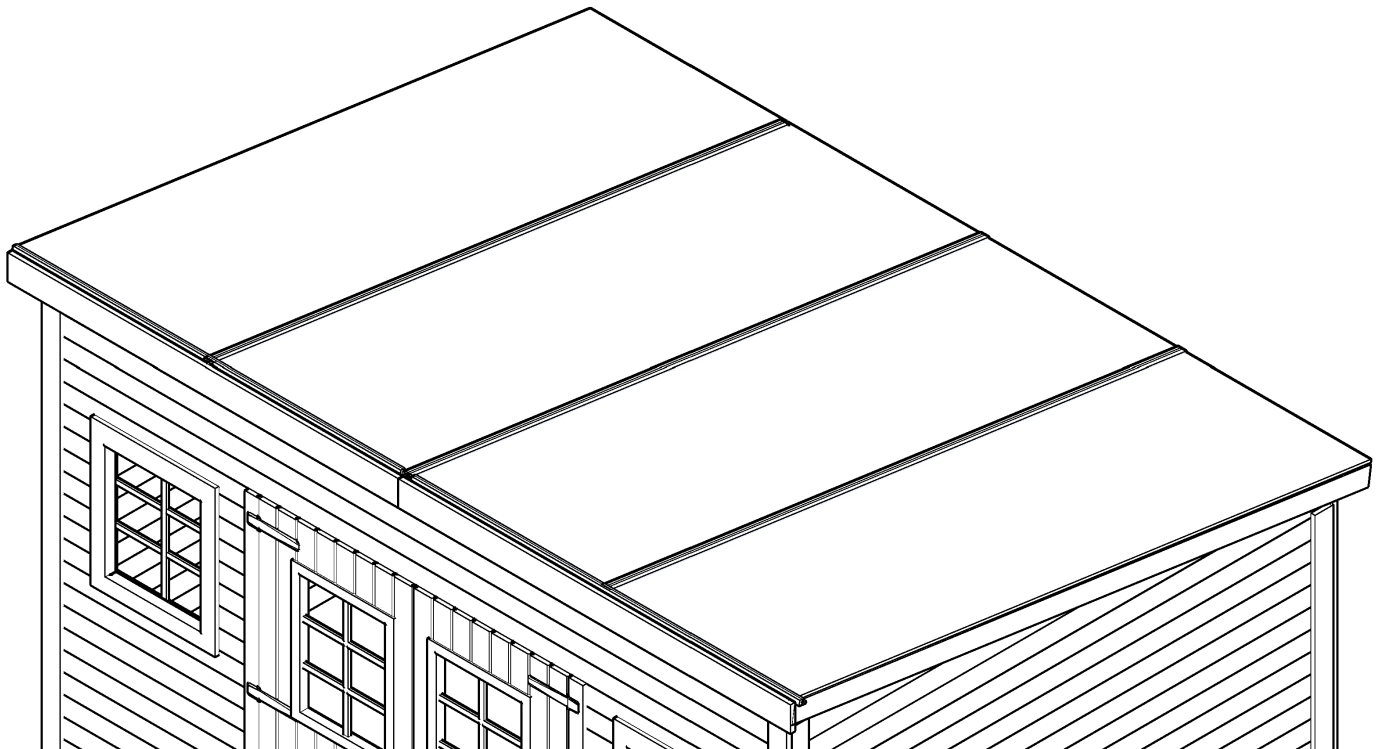

À l'aide d'un cutter, découpez une feuille de polycarbonate à une largeur de 840 mm.

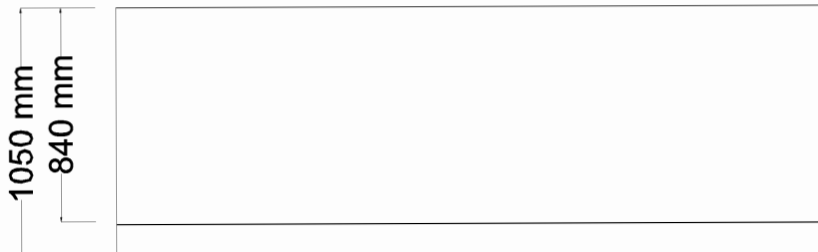

LA 4030

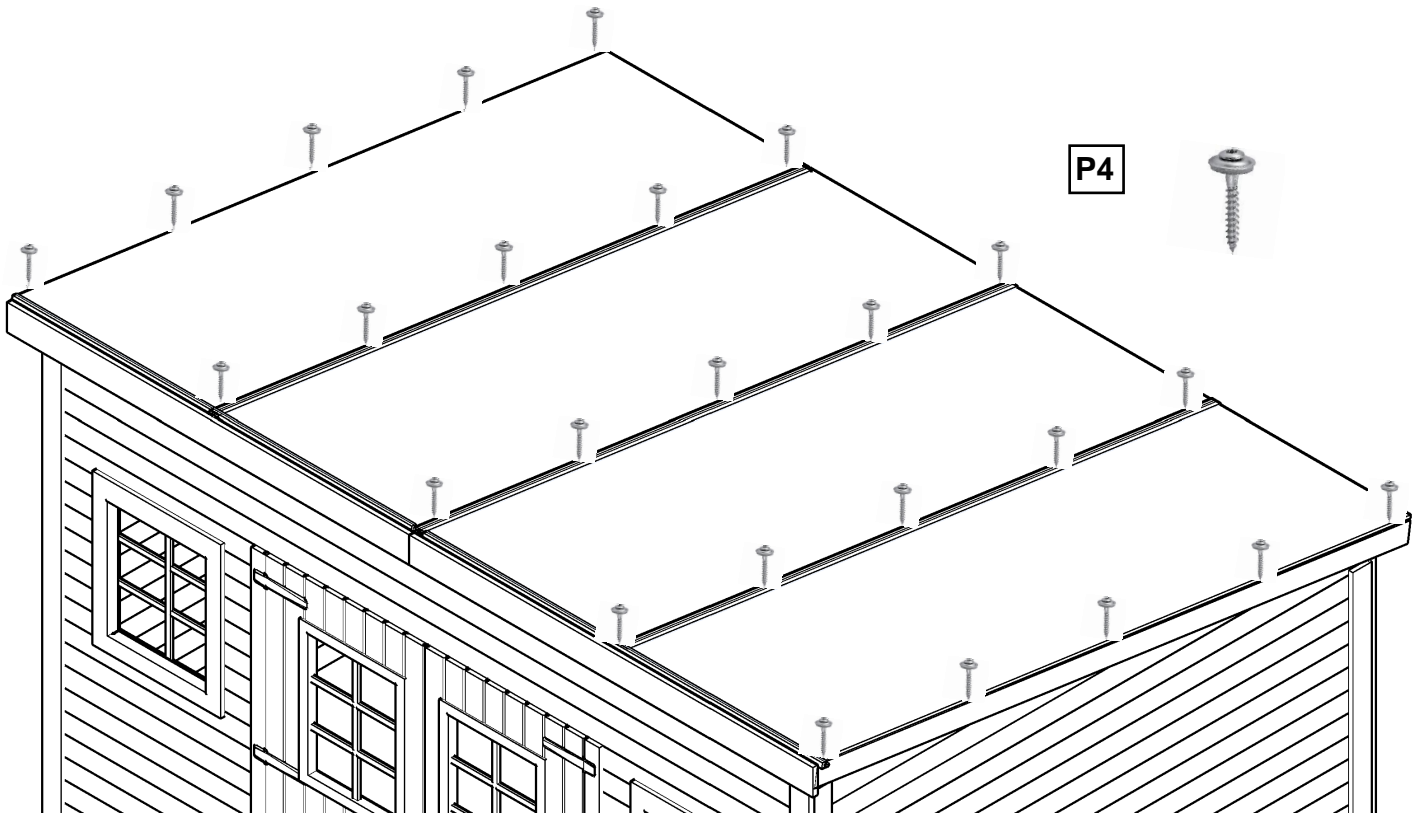
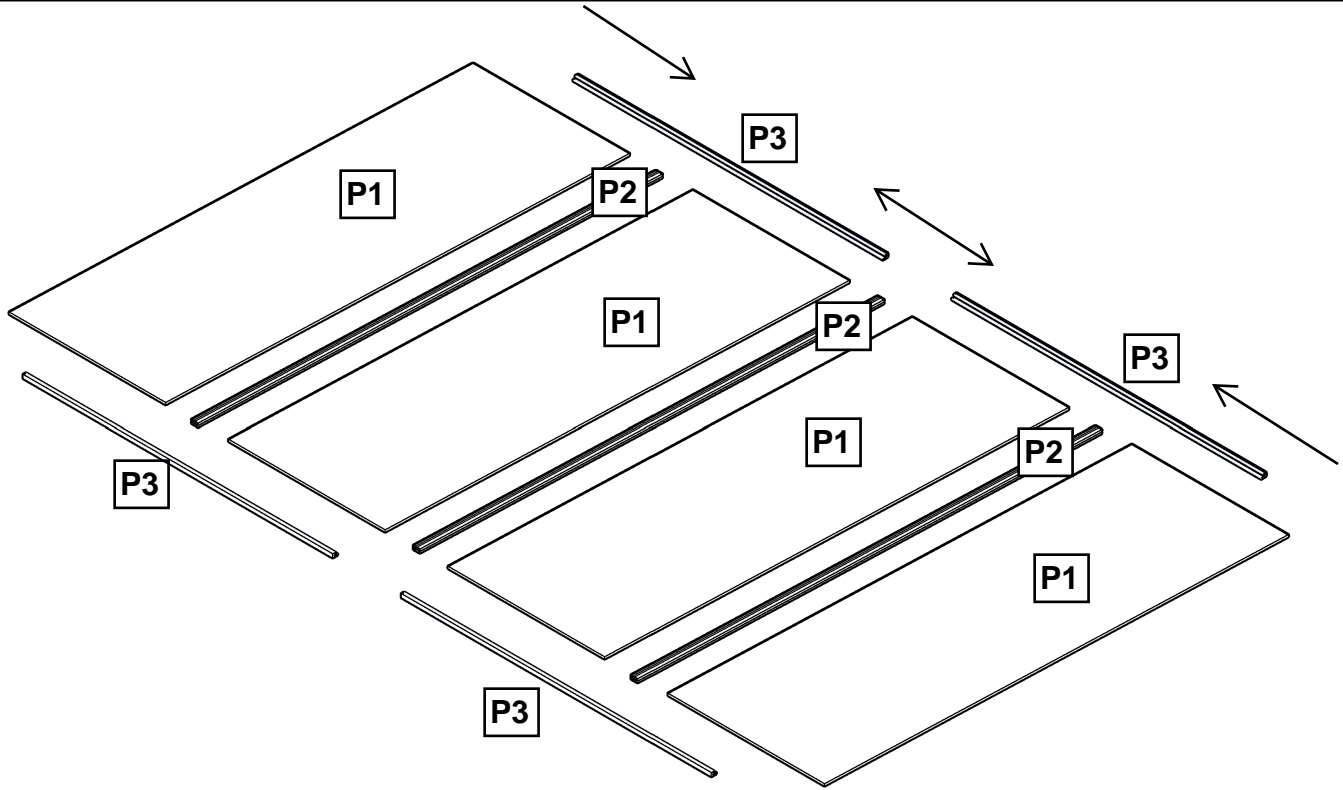

LA 4030

FIXATION CADRE PORTE

Vue extérieure

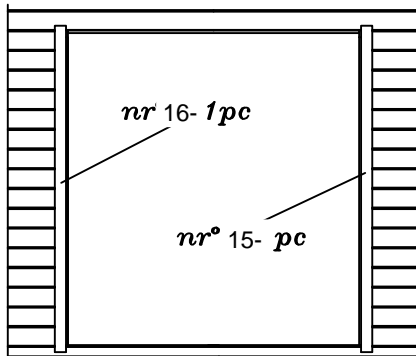

Ne pas visser les vis dans les madriers afin de les laisser travailler librement et éviter les espacements entre madriers.

Vue intérieure

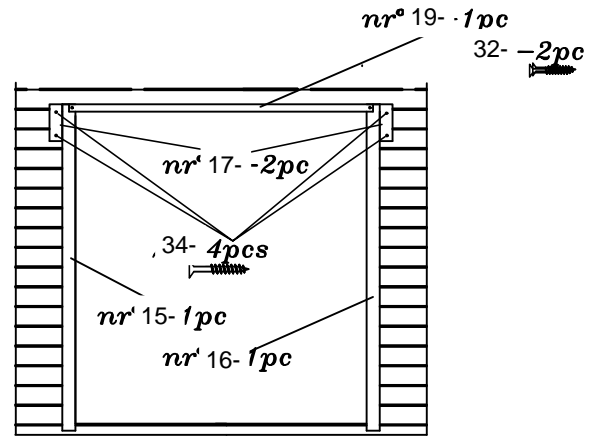

FIXATION QUINCAILLERIE ET DECORATIONS PORTE

Vue extérieure

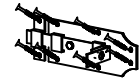
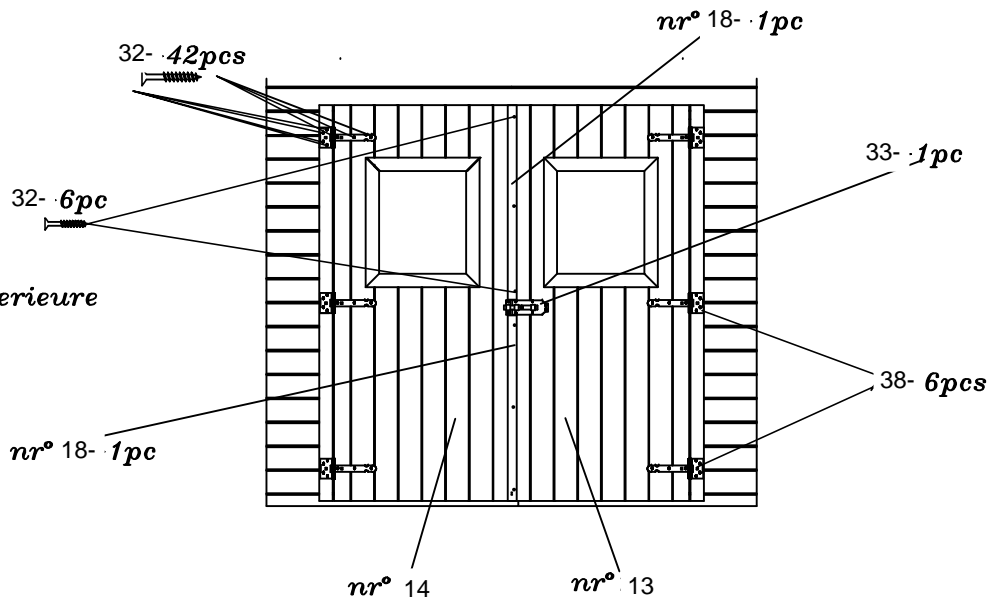

FIXATION VERROU A DOUILLE

Vue intérieure

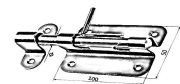
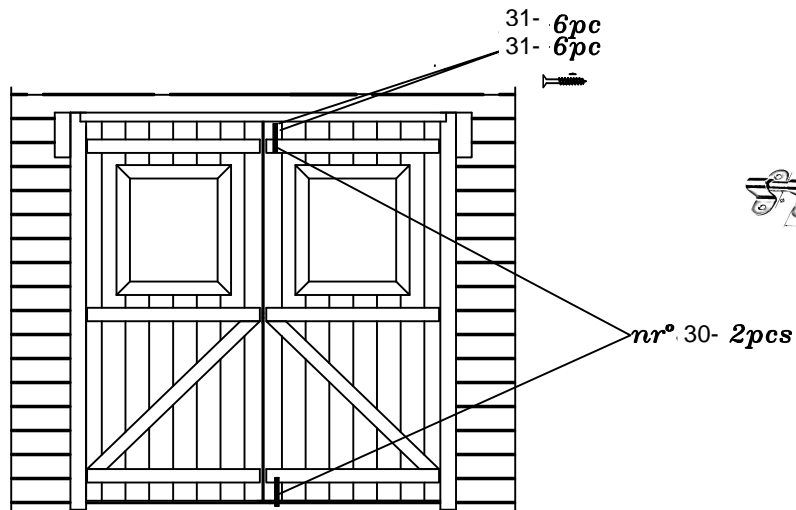

LA 4030

Paroi facade, vue de l'exterieur

1.	1	L28.0.3744d	3744*108*	28
2.	1	L28.0.3744d	3744*108*	28
3.	7+7	L28.0.1027	1027*108*	28
4.	5	L28.0.2744	2744*108*	28
35.	32	L28.0.228	228*108*	28

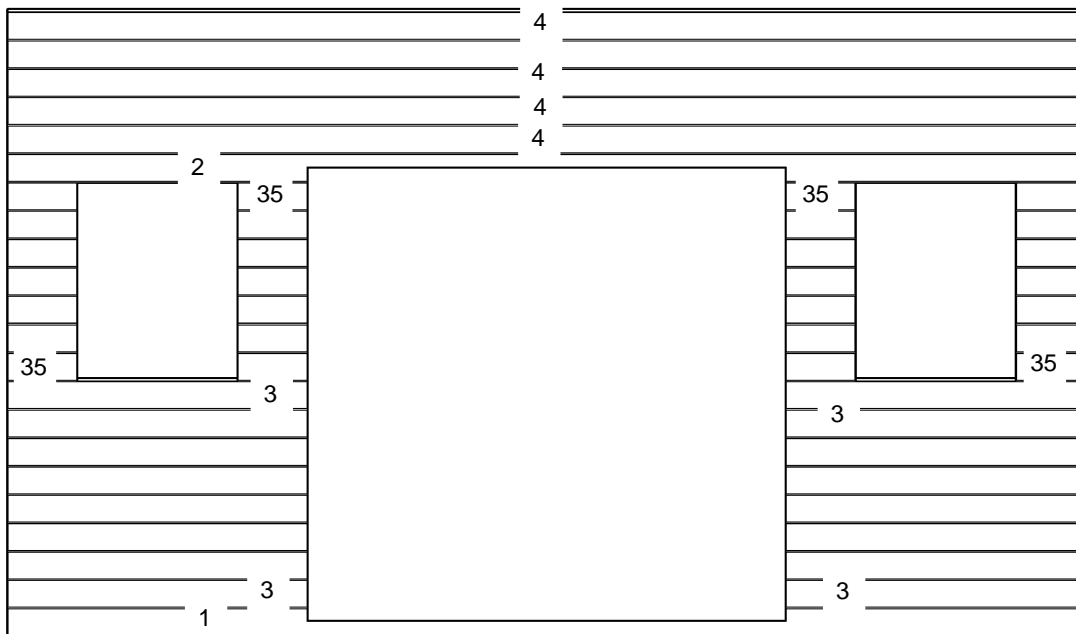

Paroi arriere, vue de l'exterieur

4.	18	L28.0.3744	3744*108*	28
----	----	------------	-----------	----

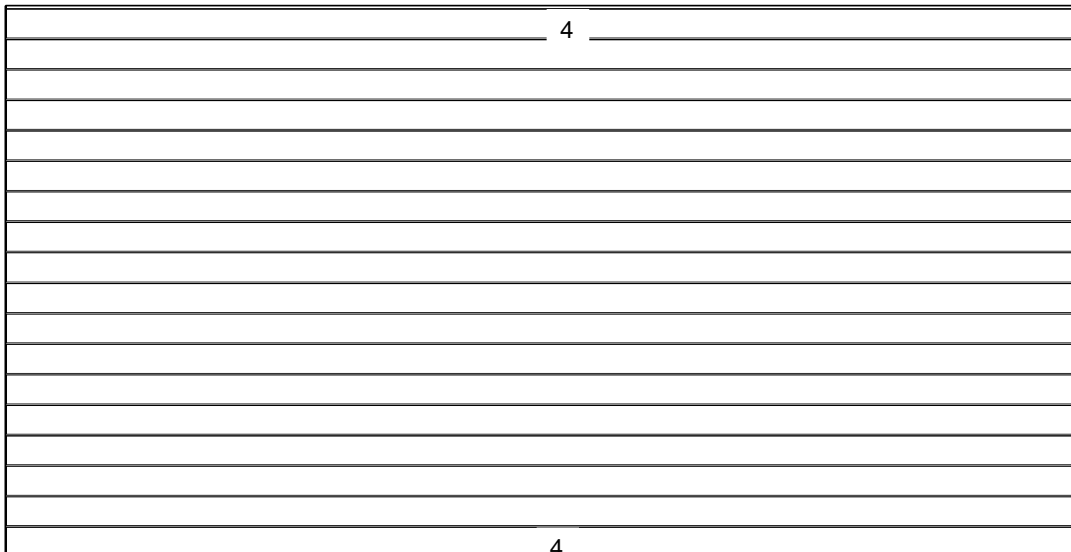

LA 4030

Paroi laterale, vue de l'exterieur

5.	17+17	L28.0.2744	2744*108* 28
6.	1+1	F2744.500	2744*500* 28

