

**ATTENTION!!!**  
Pour éviter d'abîmer  
vos pièces de bois, il  
faut les pré-percer  
avant de visser.

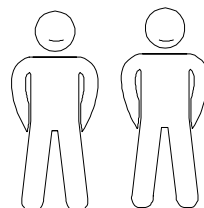
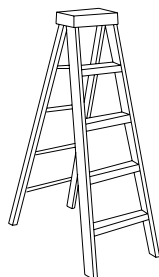

**LA 4040**

**Code EAN : 3701406705397**

**Colis n° :**  
**(à rappeler impérativement pour  
toute demande SAV)**

maj 28.01.2026

PLAN DE SOUBASSEMENT

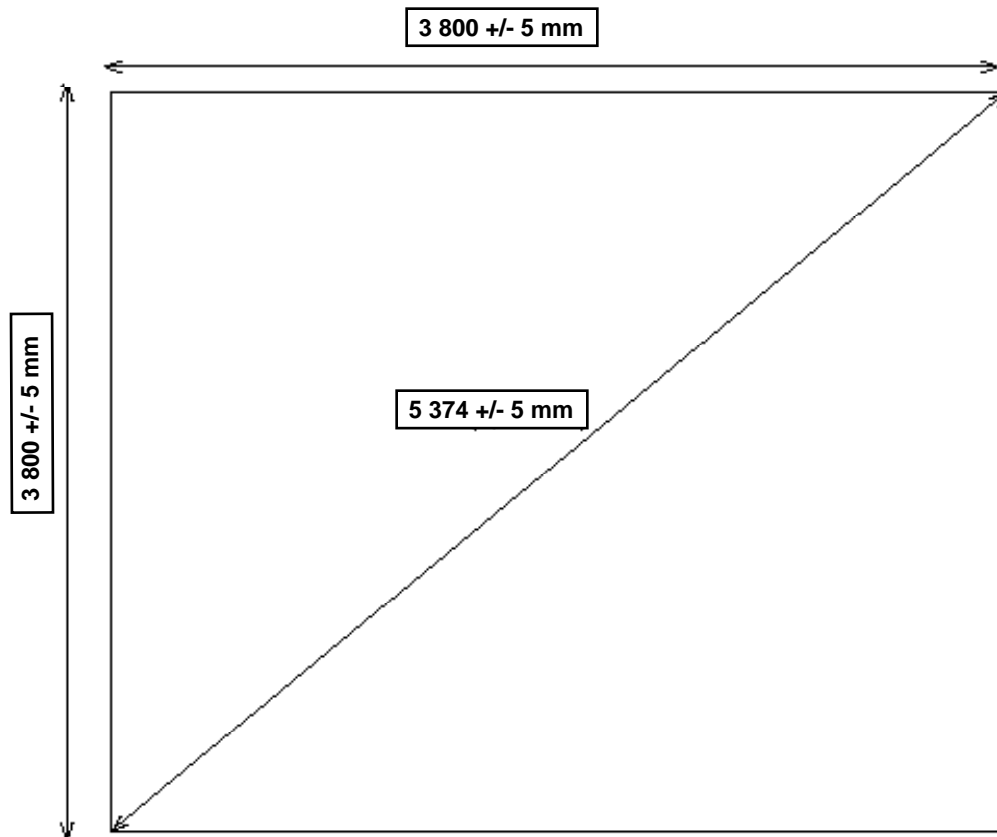

Les dimensions données sur le plan de soubassement sont les dimensions de la dalle béton à réaliser sur un sol parfaitement plat sans aucun autre objet extérieur type mur, clôture ou arbre dans l'entourage de la dalle.  
Si le produit est implanté près d'un mur, d'une haie ou d'un arbre il est nécessaire de l'éloigner des éléments extérieurs afin de pouvoir facilement le monter et l'entretenir. Nous nous dégageons de toute responsabilité en cas de mauvaise interprétation des dimensions de la dalle.

Le dimensioni del piano di base sono le dimensioni della soletta di cemento da realizzare su un terreno perfettamente piatto, senza alcun altro oggetto esterno, come un muro, una recinzione o un albero in prossimità delle soletta. Se il prodotto è installato vicino ad una parete, un recinto o un albero, è necessario distanziarlo adeguatamente, in modo da poterlo facilmente montare e farne la manutenzione. Non ci assumiamo alcuna responsabilità per l'errata interpretazione delle dimensioni delle lastra.

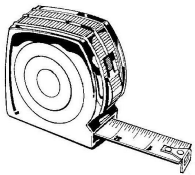

Tolérances à respecter (selon DTU 31.2):











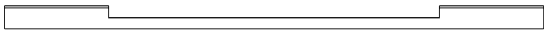

- longueur et largeur: + 0,01m;
- équerage: +0,01m mesuré sur 10m;
- arase: +0,01m sur une longueur de 10 mètres linéaires alignés ou non et de + 2mm par mètre linéaire;
- rectitude de bords en plan: +5mm .

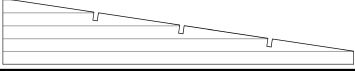
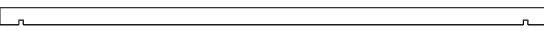
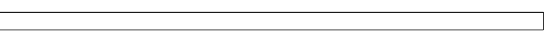
## NOTICE DE MONTAGE

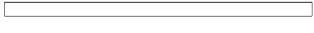
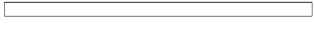
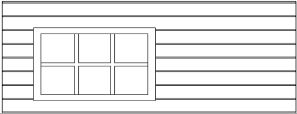
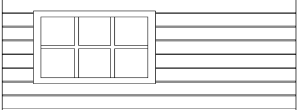
3/13

## LA 4040

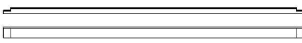
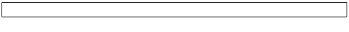
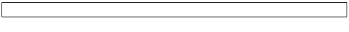
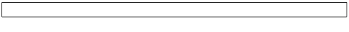
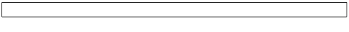
Demande SAV

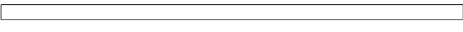
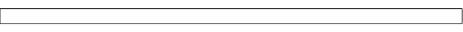
Nr.	Qte	Dessin pièce	Ref	Dimensions	Observation	Qte
1.	1		L28.0.3744d	3744*108* 28		
2.	1		L28.0.3744d	3744*108* 28		
3.	14		L28.0.1027	1027*108* 28		
4.	23		L28.0.3744	3744*108* 28		
5.	34		L28.0.3744	3744*108* 28		
6.	2		F3744.500	3744*500* 28 à démonter		
7.	4		P4000.125	4000*125* 40		
8.	2		PF4000.90	4000* 90* 40		
9.	3		PD400.90	400* 90* 40		
11.	2		PF2180.70	2180* 70* 40		
12.	2		PF1780.70	1780* 70* 40		
13.	1		UD1690.48	1690*800* 48		
14.	1		US1690.48	1690*800* 48		
15.	1		TLD1690.68	1690* 80* 68		
16.	1		TLS1690.68	1690* 80* 68		
17.	2		ELT200.70	200* 70* 20		
18.	2		DP810.70	810* 70* 20		
19.	1		EST1680.40	1680* 40* 20		
20.	2		DC2180.90	2180* 90* 20		
21.	2		DC2110.90	2110* 90* 20		
22.	2		DC1780.90	1780* 90* 20		
23.	2		DC1710.90	1710* 90* 20		
24.	8		R680.20	680* 90* 20		
25.	2		DF2020.125	2020* 125* 20		
26.	2		DL4005.90	4005* 90* 20		







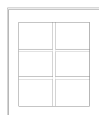

maj 28.01.2026

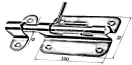
# NOTICE DE MONTAGE

## LA 4040

4/13

28.	32		L28.0.228	228* 108* 28
29.	2		FF770.640.28	770* 640* 68

Nr.	Qte	Dessin pièce	Ref	Dimensions	Observation	Qte
30.	2		Verrou a douille			
31.	12		Vis4.0*20			
32.	58		Vis4.0*30			
33.	1		Loquet			
34.	103		Vis4.0*45			
35.	14		Vis5.0*60			
36.	322		Vis4.5*50			
37.	6		ClouL80			
38.	6		Pentures BG150			

**A compléter impérativement pour toute demande SAV et à envoyer par mail à  
+ photo des pièces abimées (To be completed imperatively + Photo of damaged parts)**

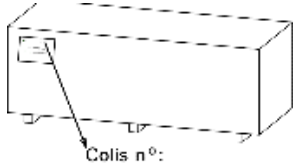
	<b>LA 4040</b> <u>Colis(package) n° :</u>	MAGASIN (STORE)	
		NOM (NAME) CLIENT	
		PRENOM(PRE.) CLIENT	
		N° de téléphone (PHONE)	

LA 4040

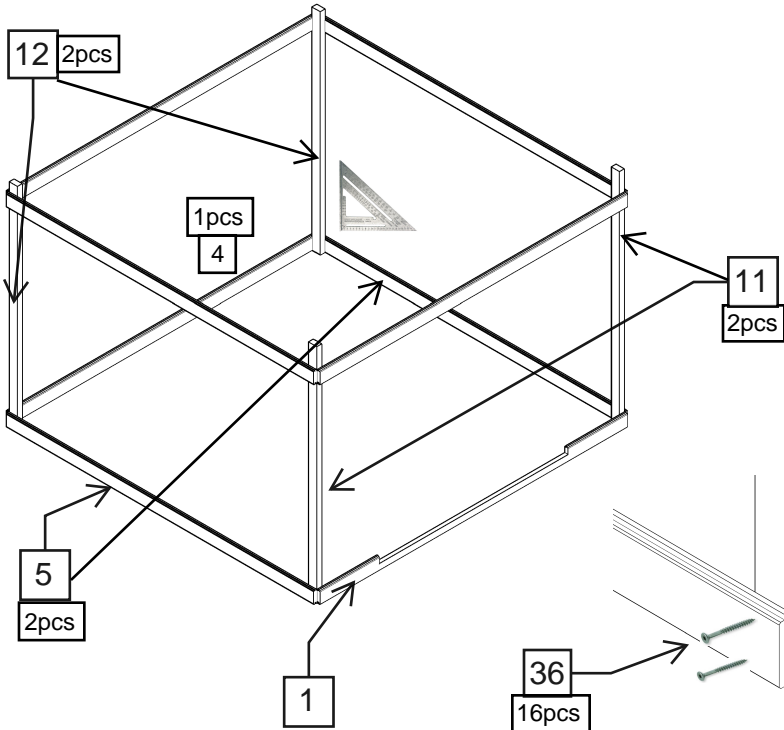

**ATTENTION!!!.**  
 pour éviter d'abimer vos  
 pièces de bois, il faut les  
 pré-percer avant de visser

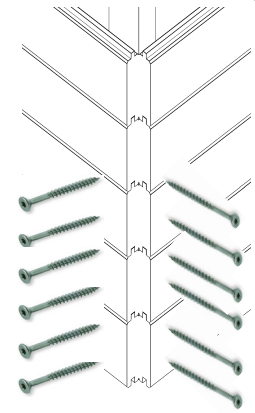
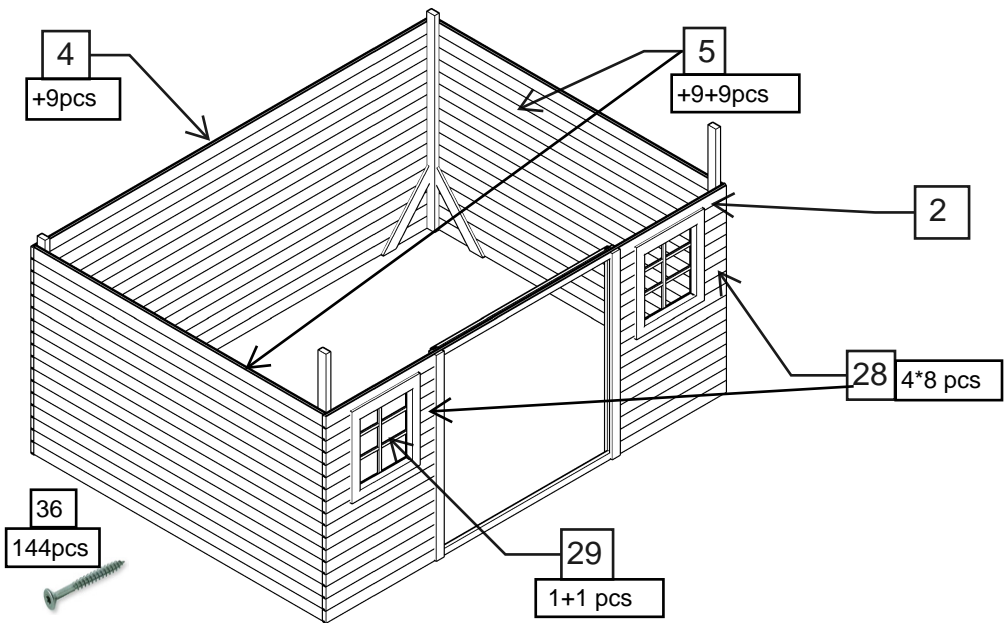
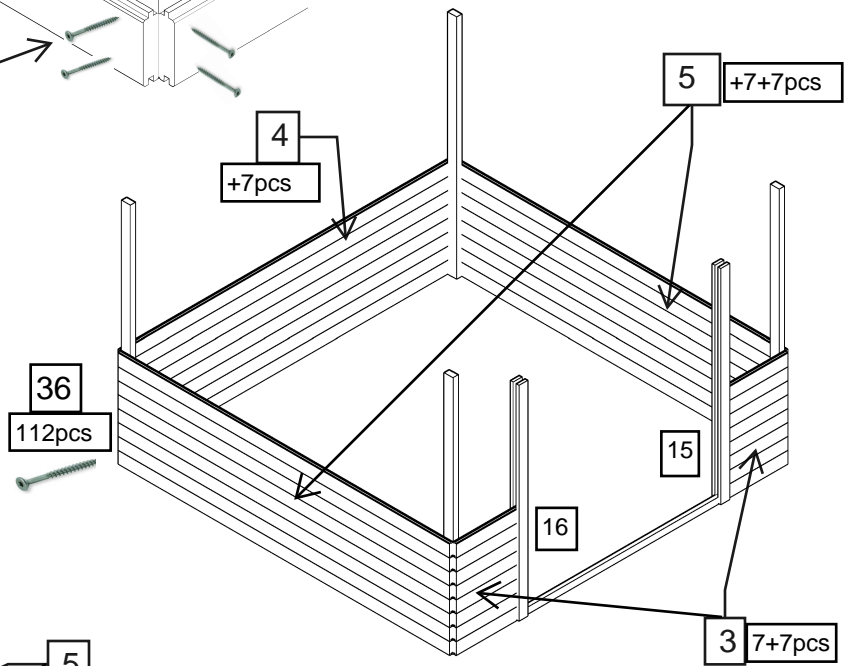
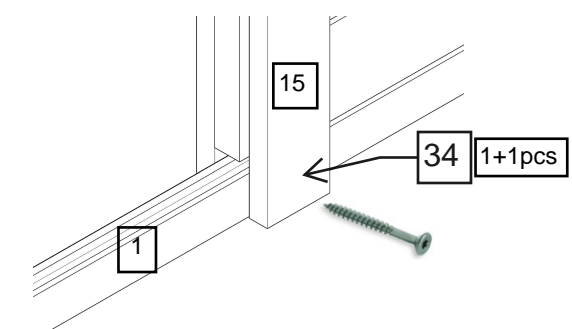

Utilisez 4 vis #36 pour fixer  
 chaque madrier aux  
 poteaux.

# NOTICE DE MONTAGE

## LA 4040

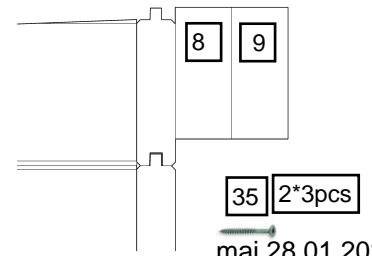
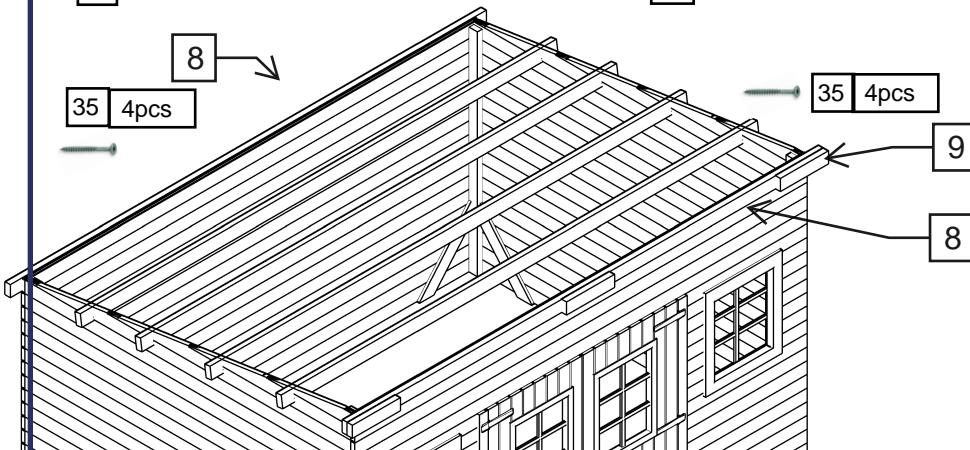
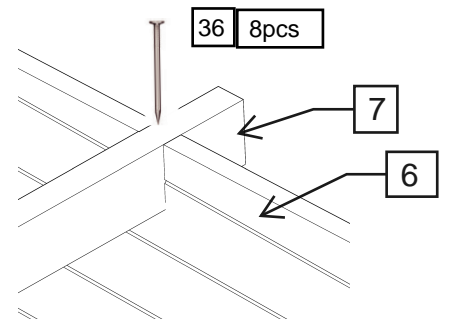
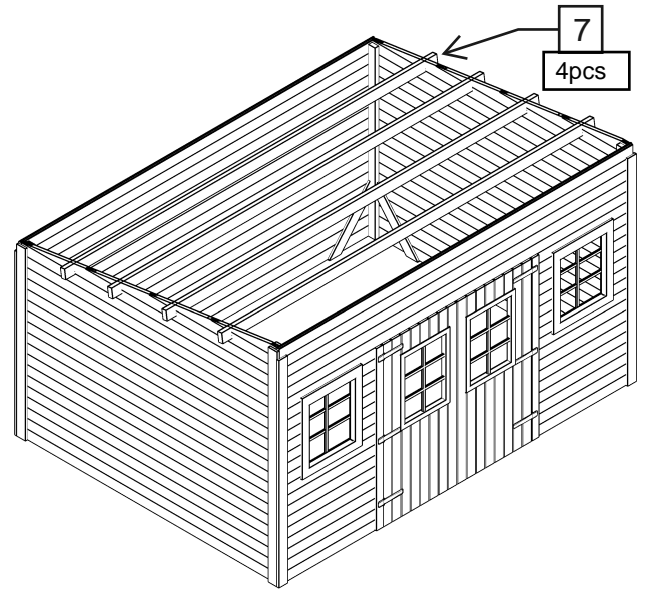
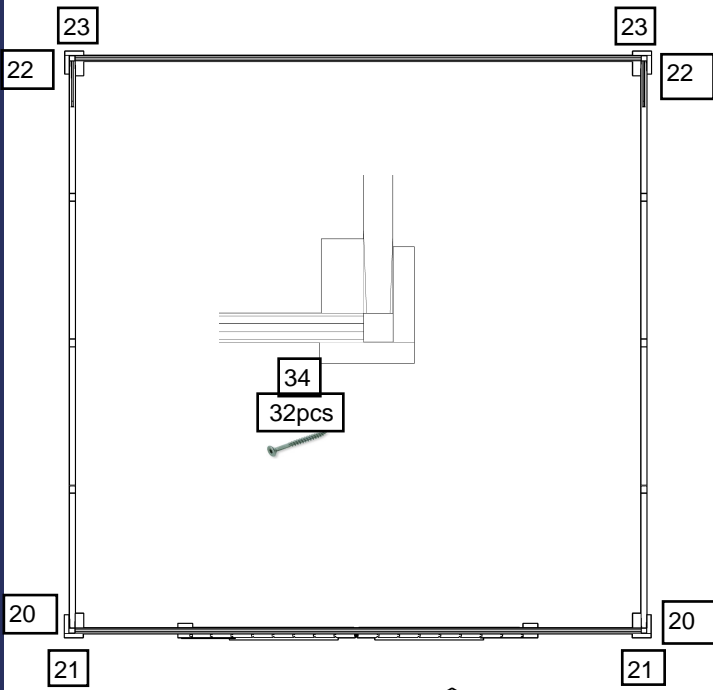
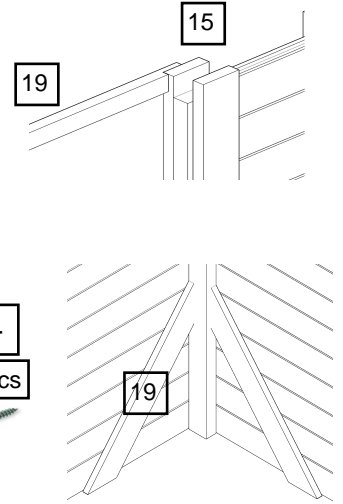
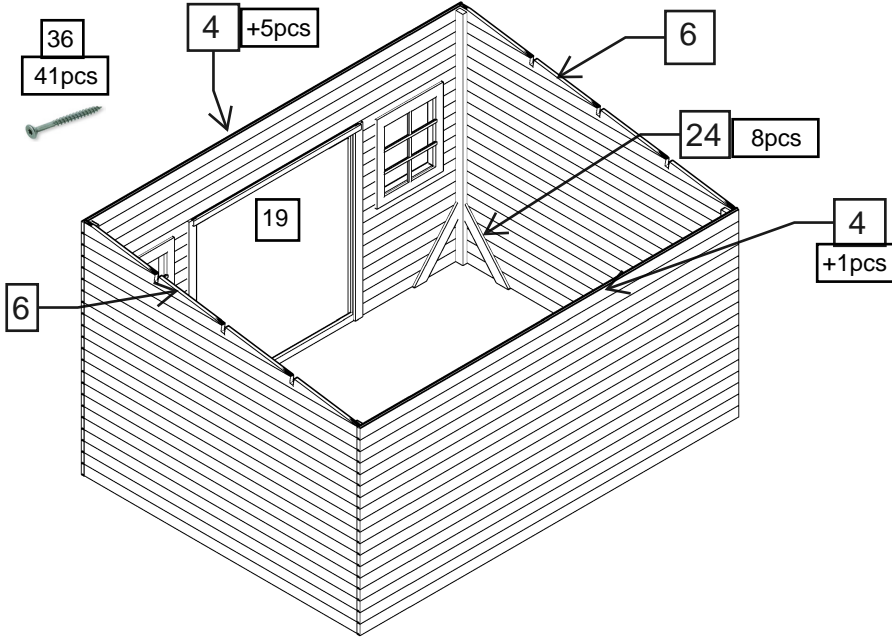

NOTICE DE MONTAGE  
LA 4040

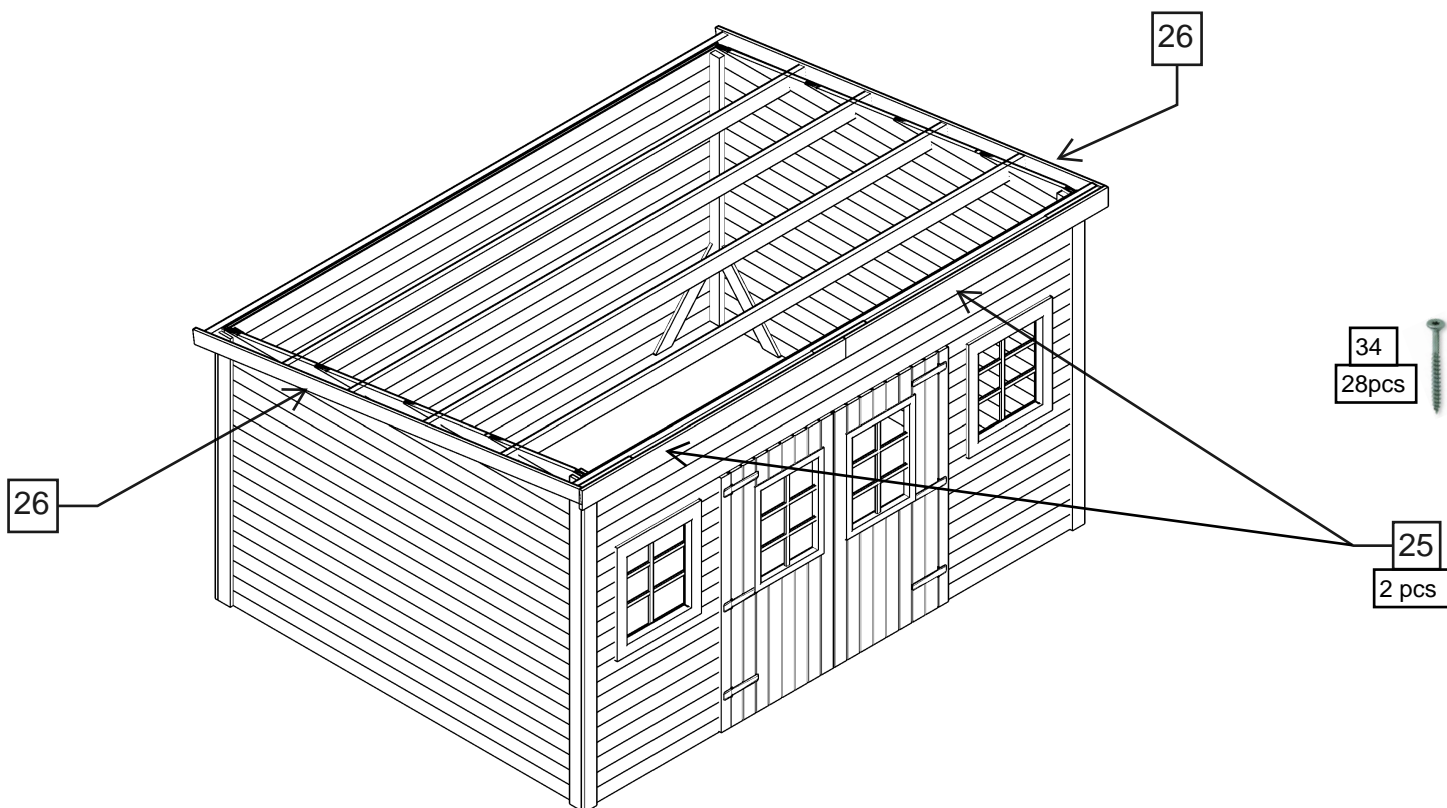



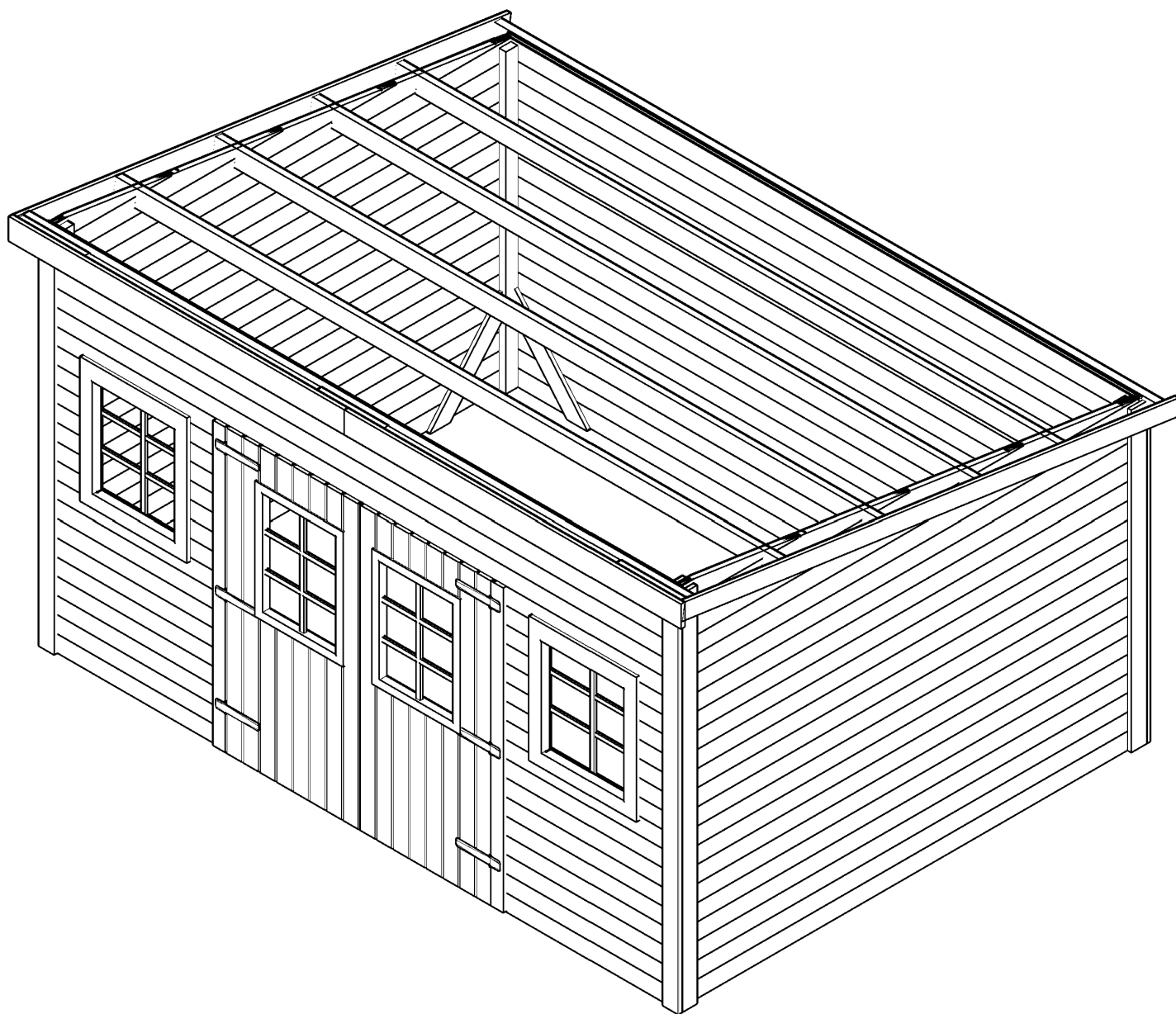

LA 4040

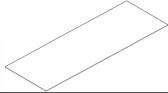

# NOTICE DE MONTAGE

9/13

## LA 4040

Nr. Qte	Dessin pièce	Ref	Dimensions	Observation	Qte
P1. 4		POL4000.1000	4000*1000* 6		
P2. 4		PRH3000	3000* 30* 6		
P3. 4		PRU2000	2000* 20* 6		
P4. 35		VIS	4,5 * 25		

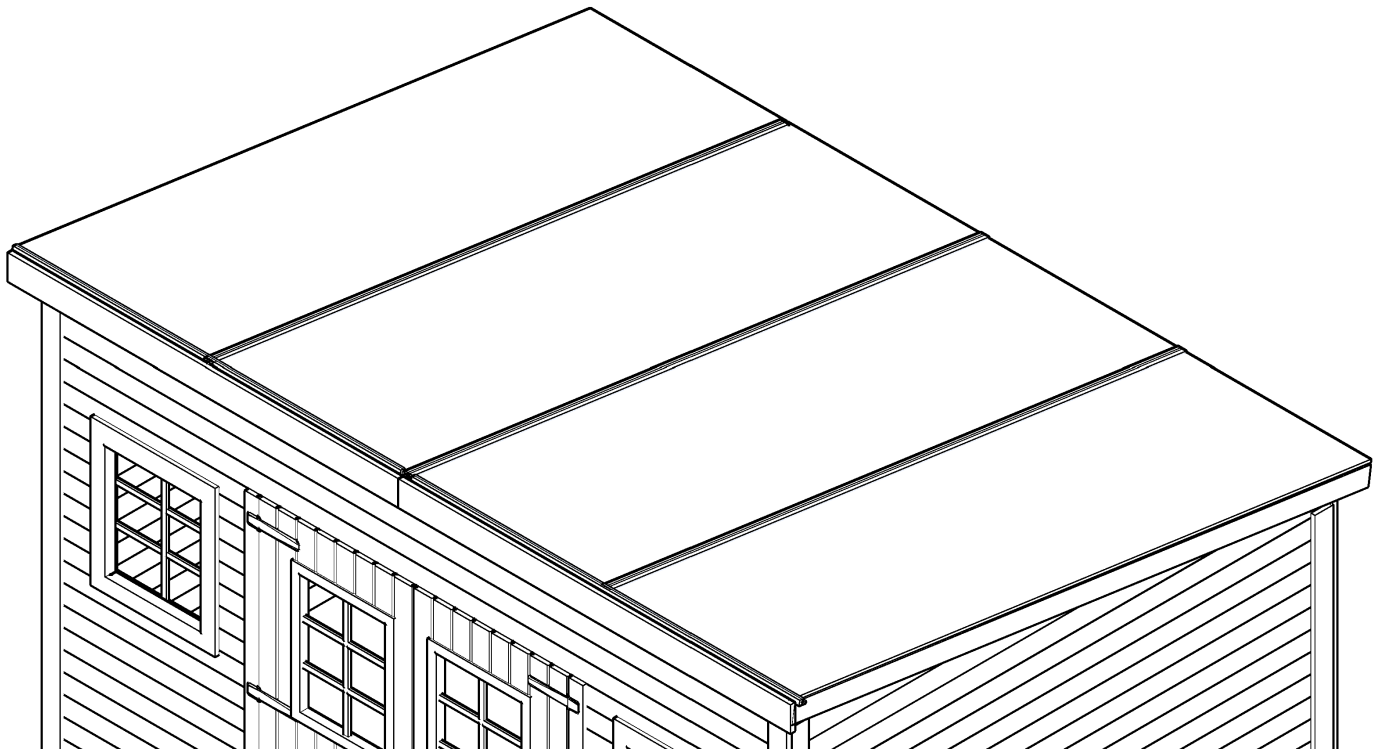

À l'aide d'un cutter, découpez une feuille de polycarbonate à une largeur de 840 mm.

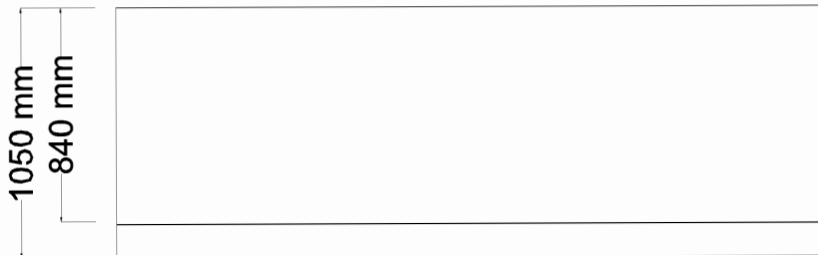

LA 4040

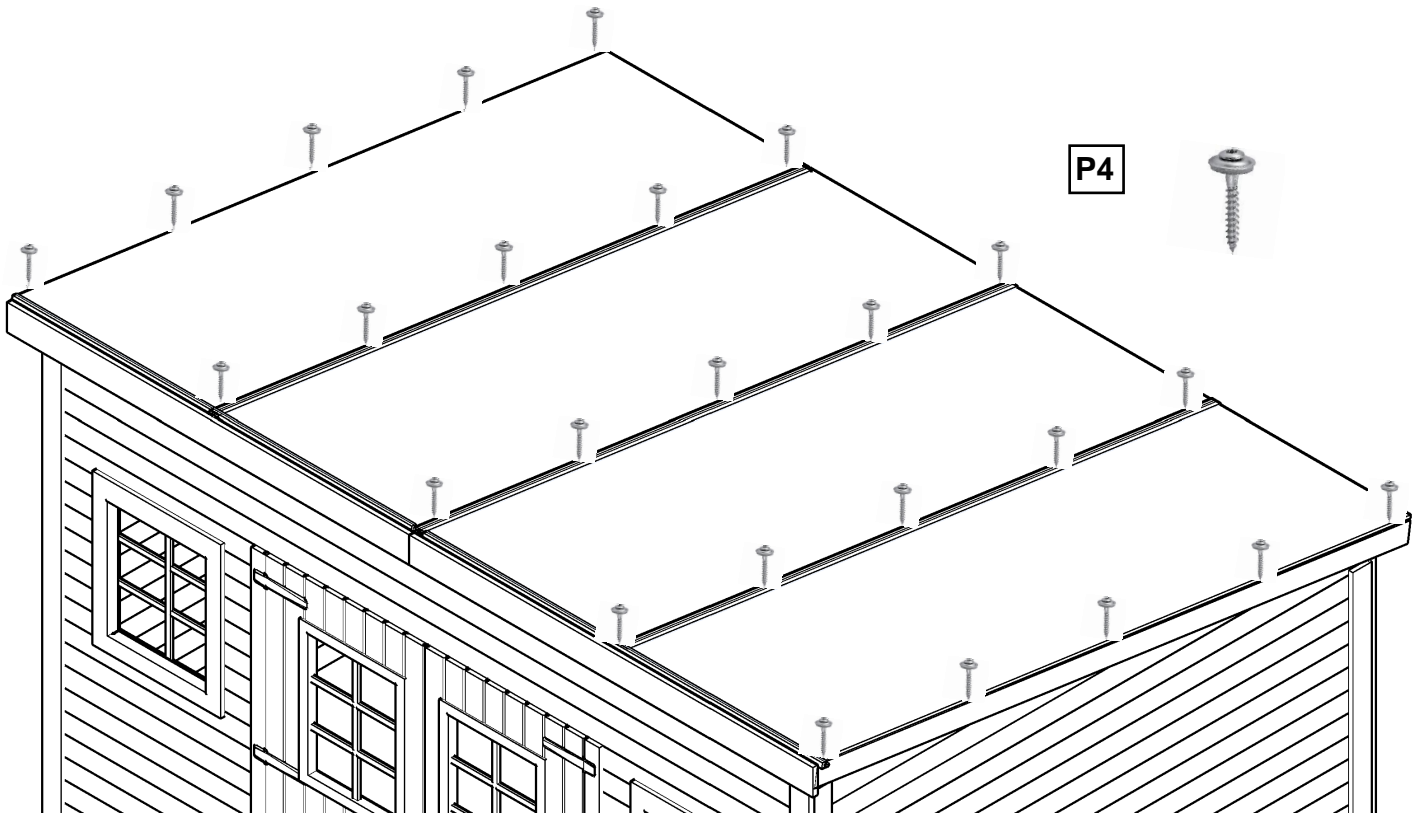
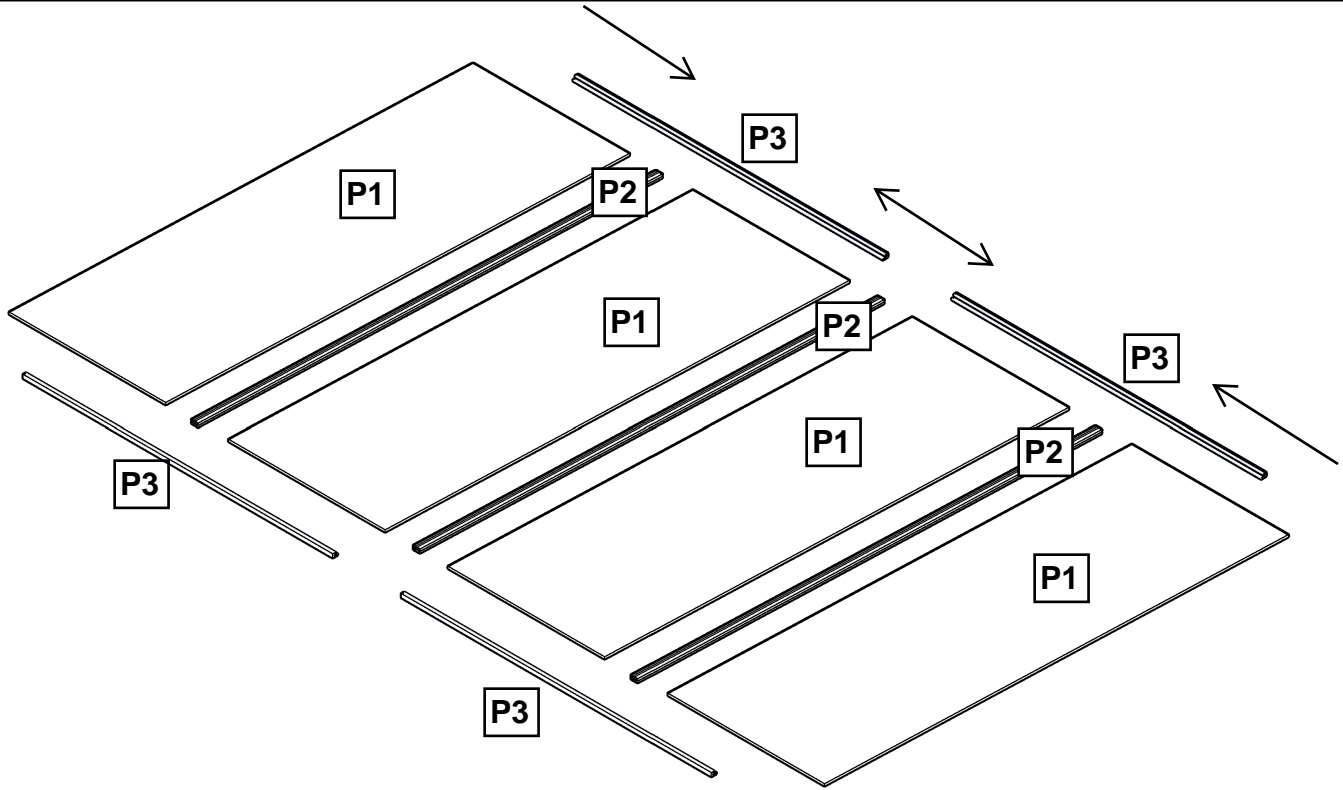

LA 4040

**FIXATION CADRE PORTE**

*Vue extérieure*

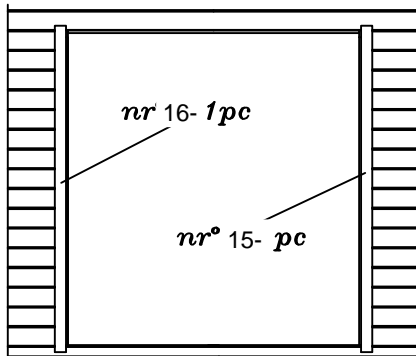

Ne pas visser les vis dans les madriers afin de les laisser travailler librement et éviter les espacements entre madriers.

*Vue intérieure*

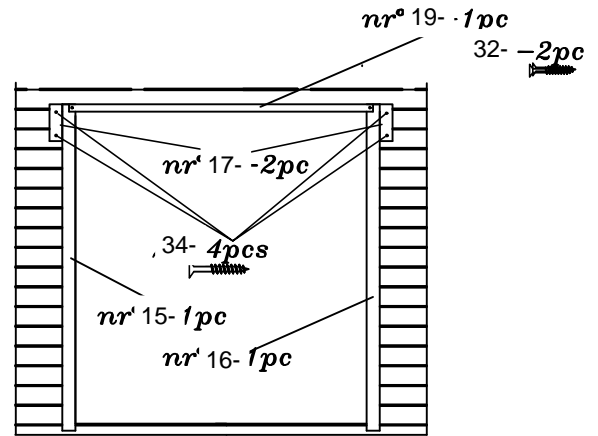

**FIXATION QUINCAILLERIE ET DECORATIONS PORTE**

*Vue extérieure*

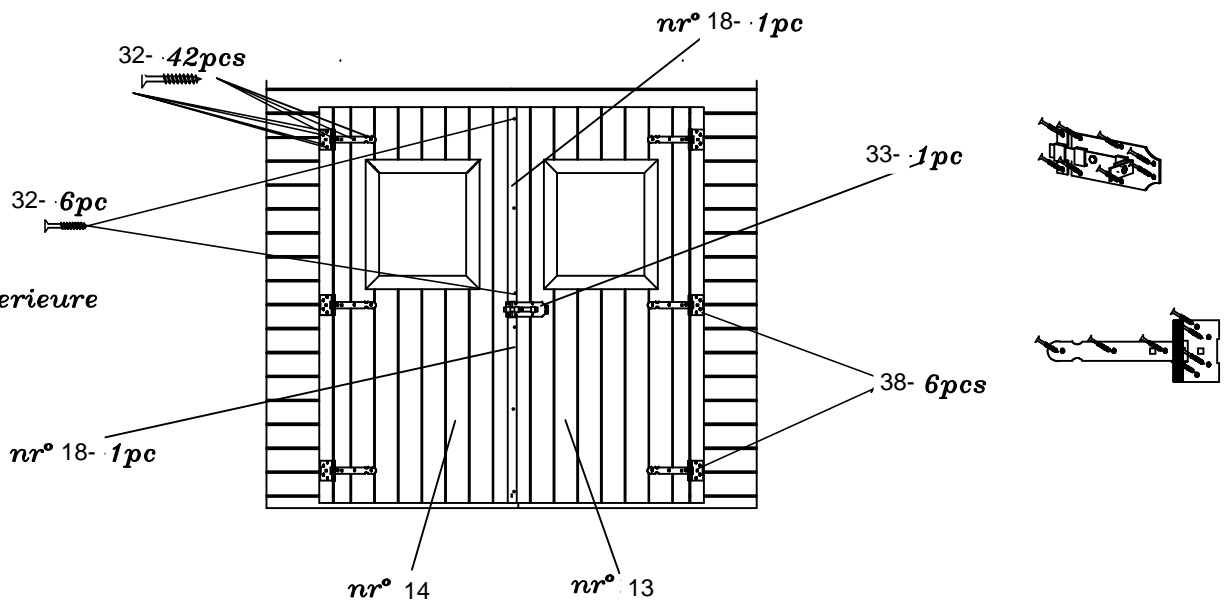

**FIXATION VERROU A DOUILLE**

*Vue intérieure*

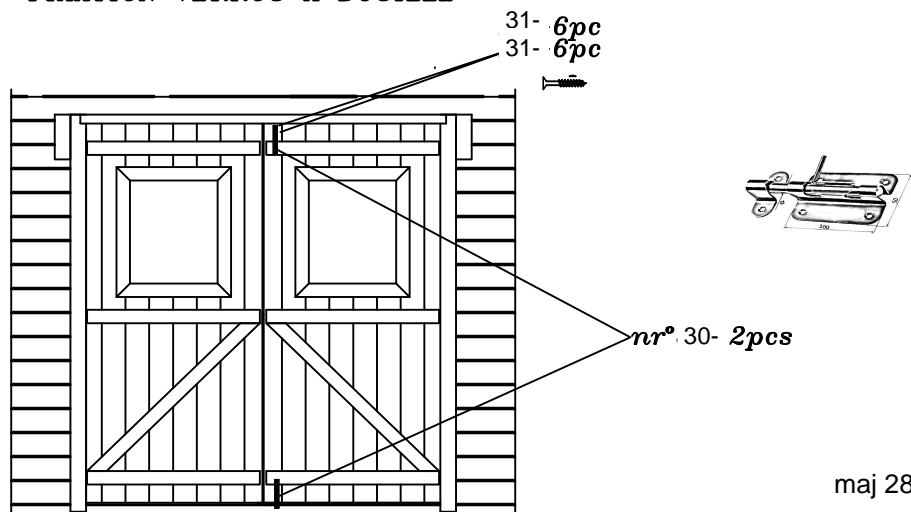

LA 4040

Paroi facade, vue de l'exterieur

1.	1	L28.0.3744d	3744*108* 28
2.	1	L28.0.3744d	3744*108* 28
3.	7+7	L28.0.1027	1027*108* 28
4.	5	L28.0.2744	2744*108* 28
35.	32	L28.0.228	228*108* 28

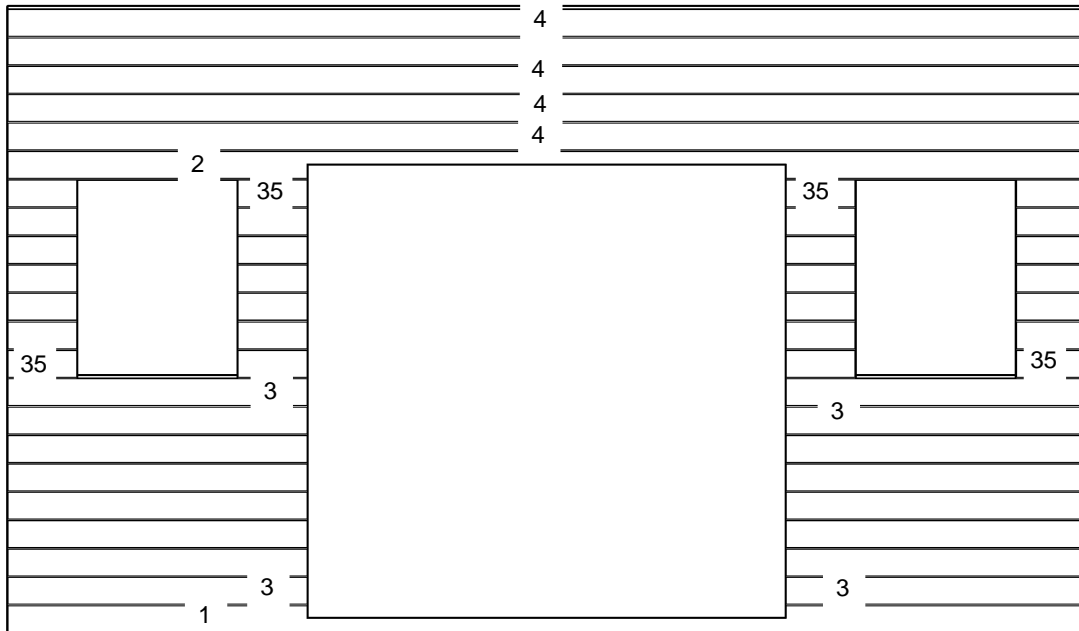

Paroi arriere, vue de l'exterieur

4.	18	L28.0.3744	3744*108* 28
----	----	------------	--------------

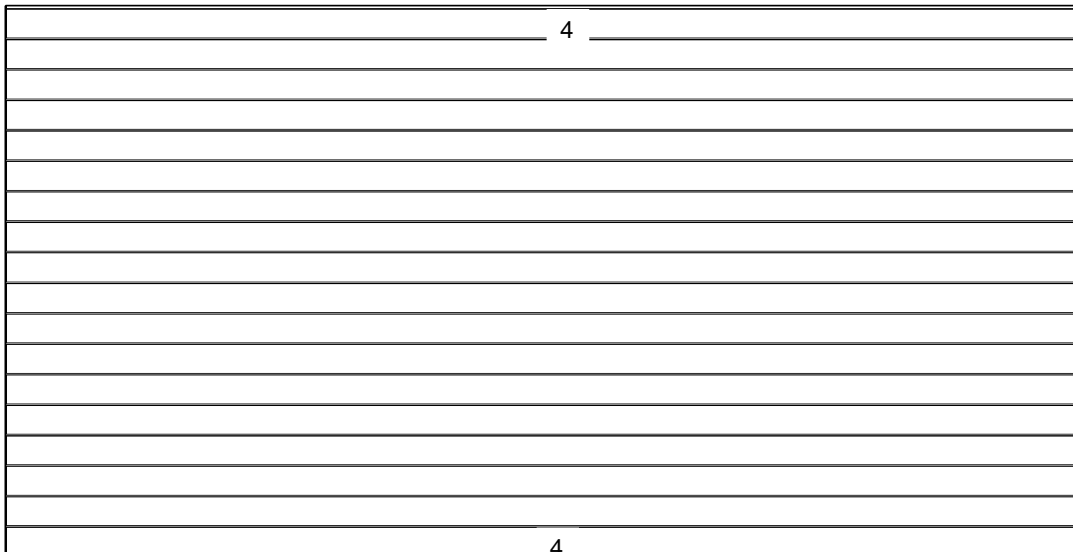

## LA 4040

## Paroi laterale, vue de l'exterieur

5.	17+17	L28.0.3744	3744*108* 28
6.	1+1	F3744.500	3744*500* 28

