

ATTENTION!!!
Pour éviter d'abîmer
vos pièces de bois, il
faut les pré-percer
avant de visser.

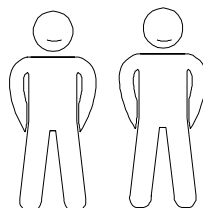

LA 4040 B
Code EAN : 3701406705434
Colis n° :
(à rappeler impérativement pour
toute demande SAV)
maj 28.01.2026

PLAN DE SOUBASSEMENT

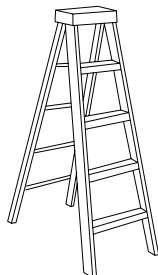
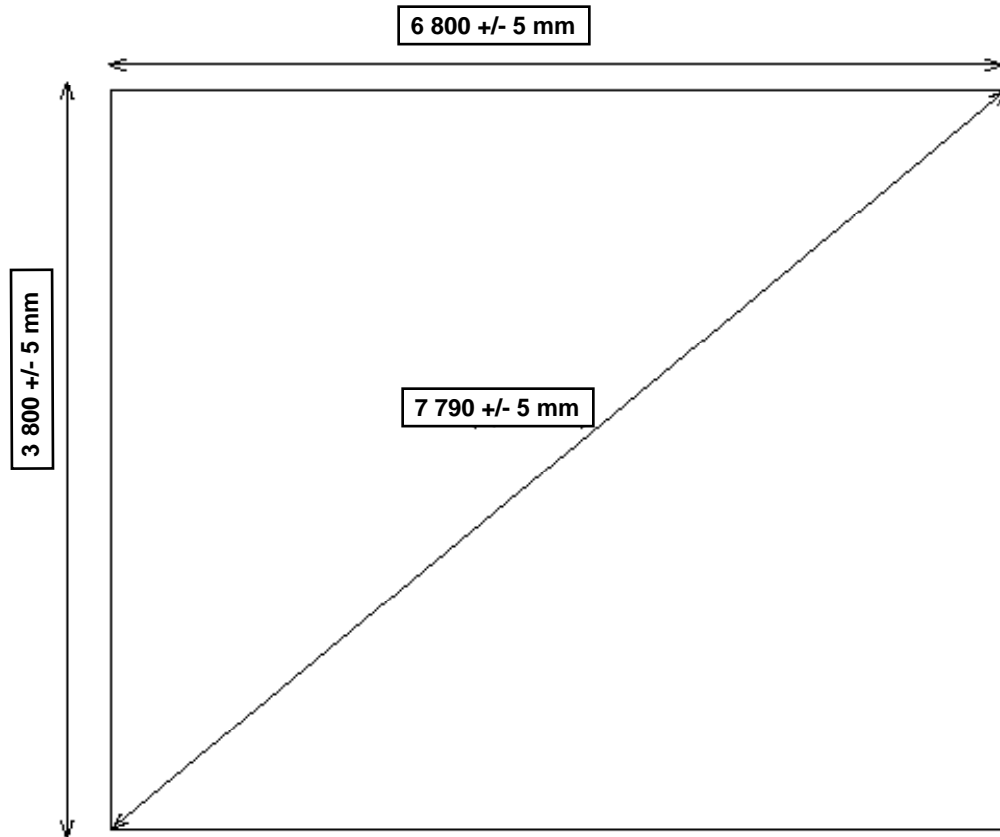

Les dimensions données sur le plan de soubassement sont les dimensions de la dalle béton à réaliser sur un sol parfaitement plat sans aucun autre objet extérieur type mur, clôture ou arbre dans l'entourage de la dalle.
Si le produit est implanté près d'un mur, d'une haie ou d'un arbre il est nécessaire de l'éloigner des éléments extérieurs afin de pouvoir facilement le monter et l'entretenir. Nous nous dégageons de toute responsabilité en cas de mauvaise interprétation des dimensions de la dalle.

Le dimensioni del piano di base sono le dimensioni della soletta di cemento da realizzare su un terreno perfettamente piatto, senza alcun altro oggetto esterno, come un muro, una recinzione o un albero in prossimità delle soletta. Se il prodotto è installato vicino ad una parete, un recinto o un albero, è necessario distanziarlo adeguatamente, in modo da poterlo facilmente montare e farne la manutenzione. Non ci assumiamo alcuna responsabilità per l'errata interpretazione delle dimensioni delle lastra.

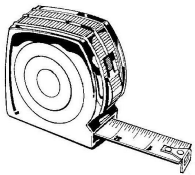

Tolérances à respecter (selon DTU 31.2):











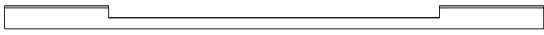

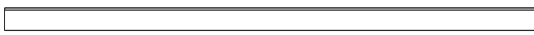



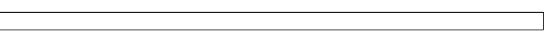

- longueur et largeur: + 0,01m;
- équerage: +0,01m mesuré sur 10m;
- arase: +0,01m sur une longueur de 10 mètres linéaires alignés ou non et de + 2mm par mètre linéaire;
- rectitude de bords en plan: +5mm .

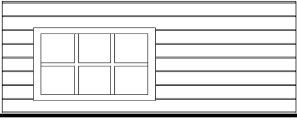
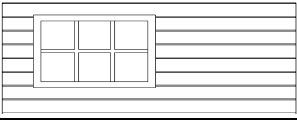
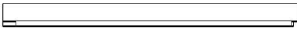
NOTICE DE MONTAGE

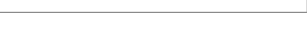
3/16

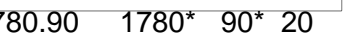
LA 4040 B

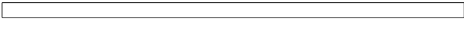
Demande SAV





Nr.	Qte	Dessin pièce	Ref	Dimensions	Observation	Qte	
1.	1		L28.0.3744d	3744*108* 28			
2.	1		L28.0.3744d	3744*108* 28			
3.	14		L28.0.1027	1027*108* 28			
4.	23		L28.0.3744	3744*108* 28			
5.	34		L28.0.3744	3744*108* 28			
6.	2		F3744.500	3744*500* 28 à démonter			
7.	4		P4000.125	4000*125* 40			
8.	2		PF4000.90	4000* 90* 40			
9.	9		PD400.90	400* 90* 40			
11.	2		PF2180.70	2180* 70* 40			
12.	2		PF1780.70	1780* 70* 40			
13.	1		UD1690.48	1690*800* 48			
14.	1		US1690.48	1690*800* 48			
15.	1		TLD1690.68	1690* 80* 68			
16.	1		TLS1690.68	1690* 80* 68			
17.	2		ELT200.70	200* 70* 20			
18.	2		DP810.70	810* 70* 20			
19.	1		EST1680.40	1680* 40* 20			
20a	1	DC2180.90	2180* 90* 20	20b	1	DC2020.90	2020* 90* 20
21.	2		DC2110.90	2110* 90* 20			
22a	1	DC1780.90	1780* 90* 20	22b	1	DC1620.90	1620* 90* 20
23.	2		DC1710.90	1710* 90* 20			
24.	8		R680.20	680* 90* 20			
25.	2		DF2020.125	2020* 125* 20			
26.	2		DL4005.125	4005* 90* 20			





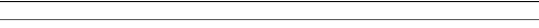

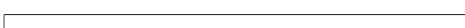

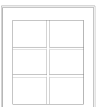
maj 28.01.2026

NOTICE DE MONTAGE

LA 4040 B

4/16

28.	1		PF2200.70	2200* 70* 80
29.	1		PF1800.70	1800* 70* 80
30.	6		PB3100.90	3100* 90* 40
31.	1		PP3820.70	3820* 70* 20
32.	1		PS3840.90	3840* 90* 40
33.	2		R680.40	680* 90* 40
34.	1		DF3000.125	3000* 125* 20
35.	32		L28.0.228	228* 108* 28
36.	2		FF770.640.28	770* 640* 68

Nr.	Qte	Dessin pièce	Ref	Dimensions	Observation	Qte
37.	2		Verrou a douille			
38.	12		Vis4.0*20			
39.	79		Vis4.0*30			
40.	1		Loquet			
41.	101		Vis4.0*45			
42.	50		Vis5.0*60			
43.	320		Vis4.5*50			
44.	8		ClouL80			
45.	6		Pentures BG150			
46.	6		Equerres metalique			
47.	2		Support poteaux bucher			

A compléter impérativement pour toute demande SAV et à envoyer par mail à sav@foresta.fr + photo des pieces abimes (To be completed imperatively + Photo of damaged parts)

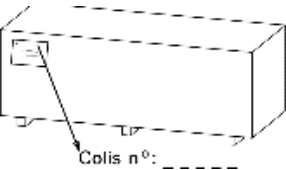
	LA 4040 B <u>Colis(package) n° :</u>	MAGASIN (STORE)	
		NOM (NAME) CLIENT	
		PRENOM(PRE.) CLIENT	
		N° de téléphone (PHONE)	

LA 4040 B

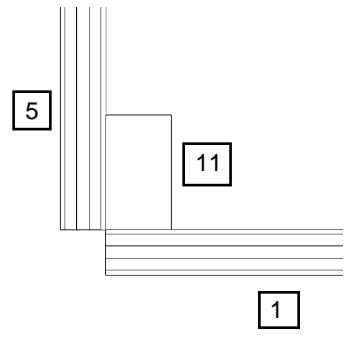
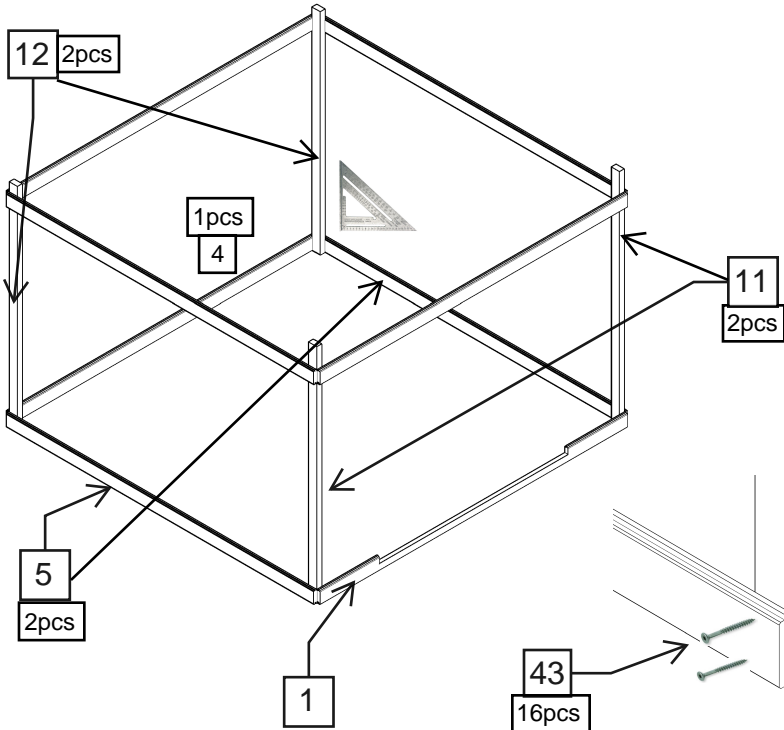

ATTENTION!!!.
pour éviter d'abimer vos
pièces de bois, il faut les
pré-percer avant de visser

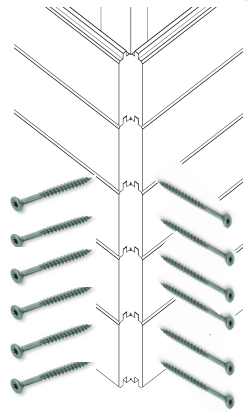
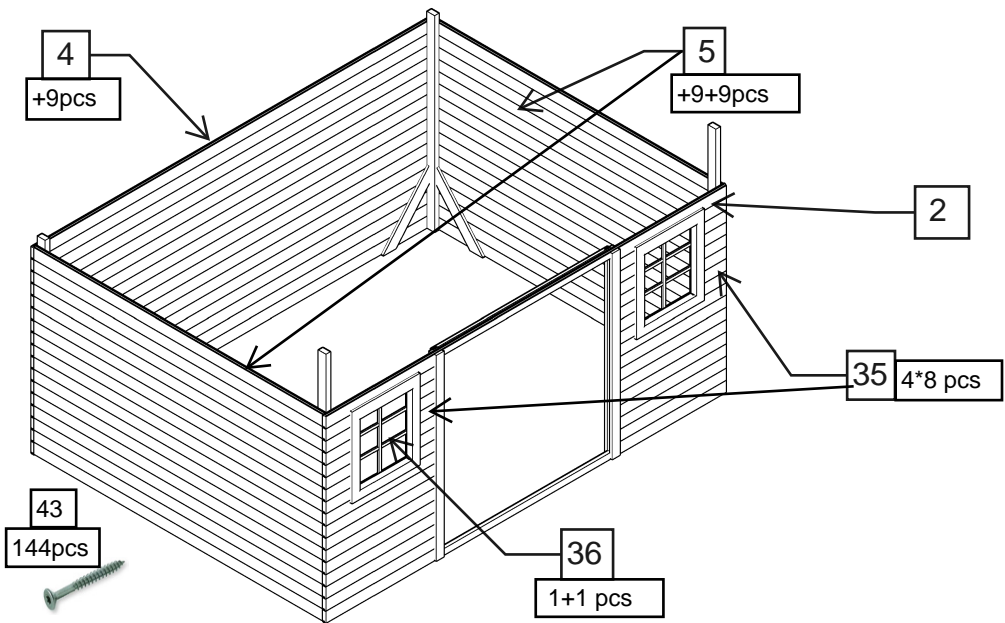
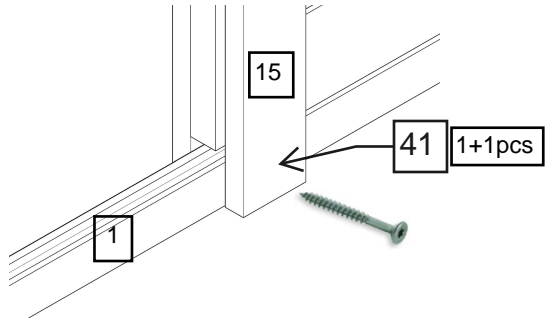
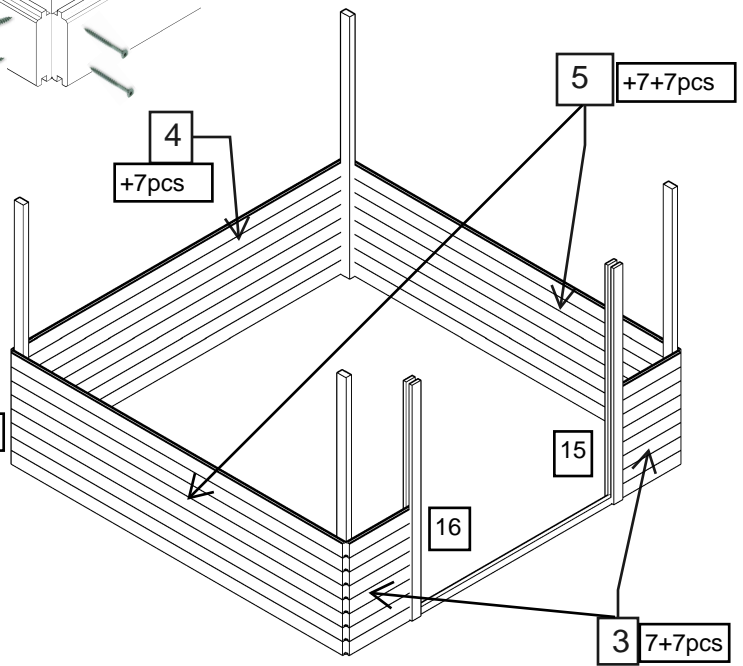
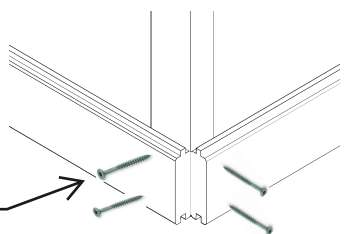

Utilisez 4 vis #43 pour fixer
chaque madrier aux
poteaux.

LA 4040 B

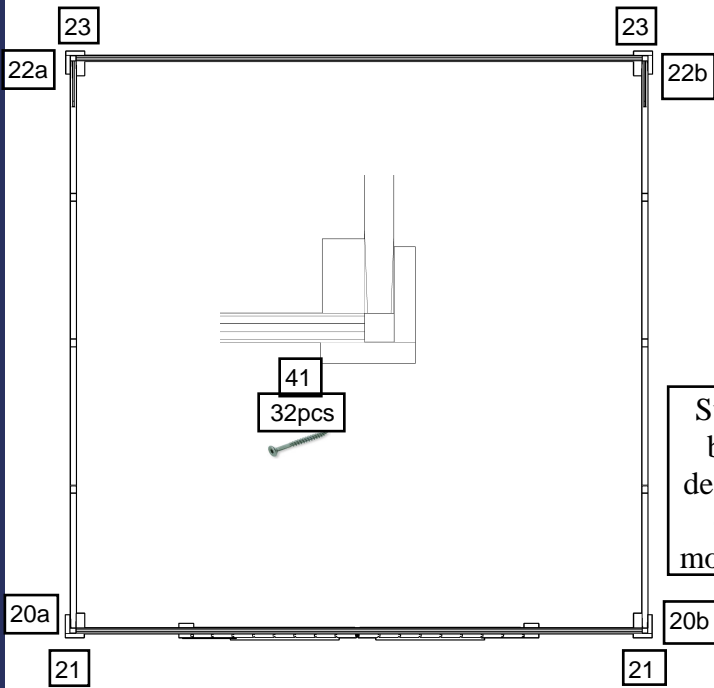
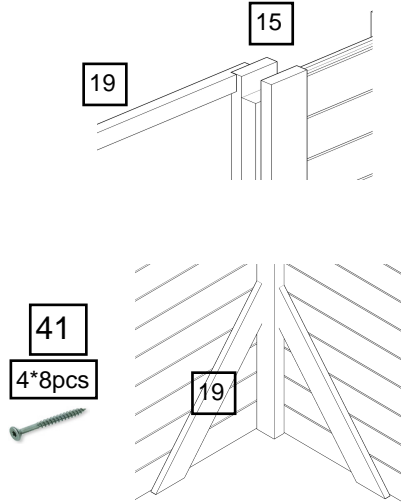
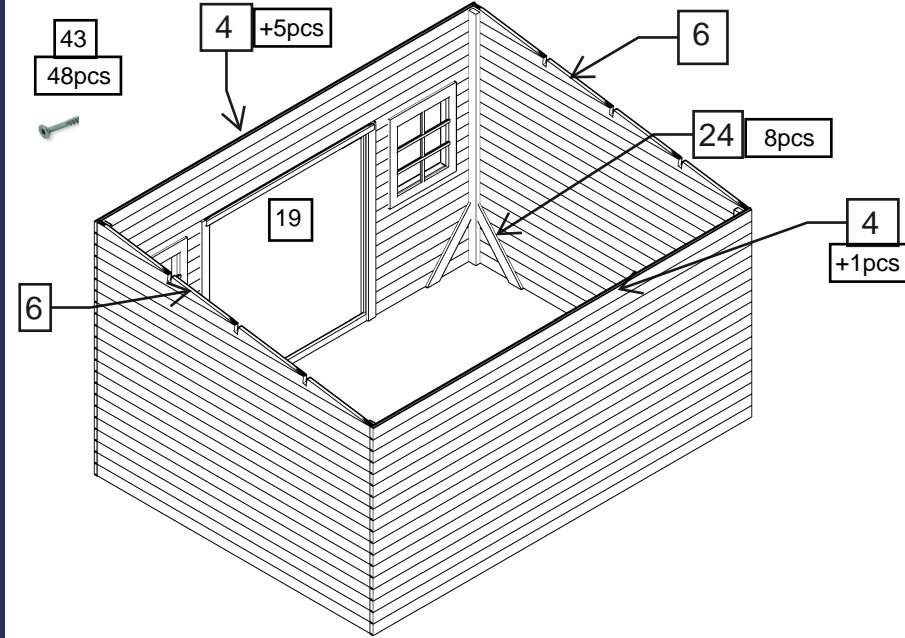

Sur la partie avec bucher fixer les decorations nr. 20b et 22b apres le montage de bucher!

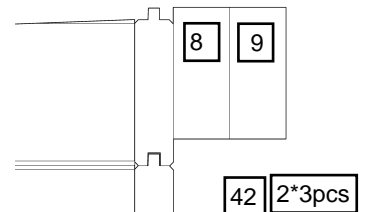
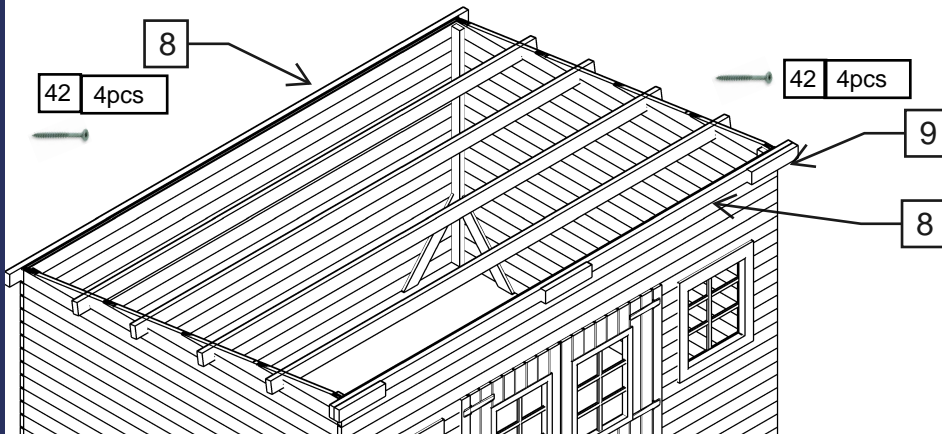
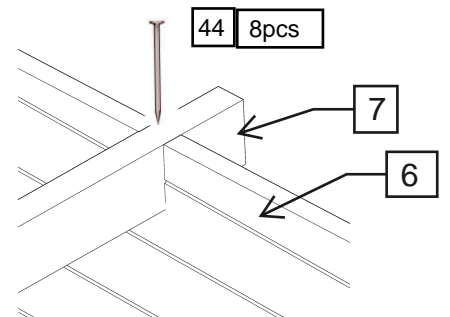
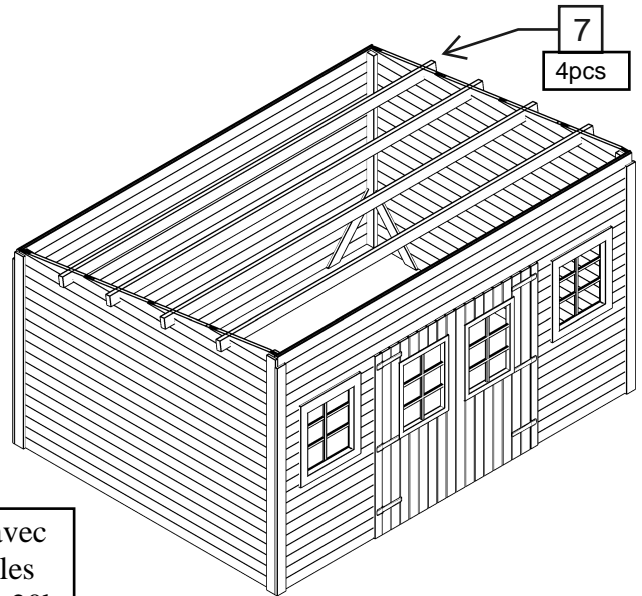

LA 4040 B

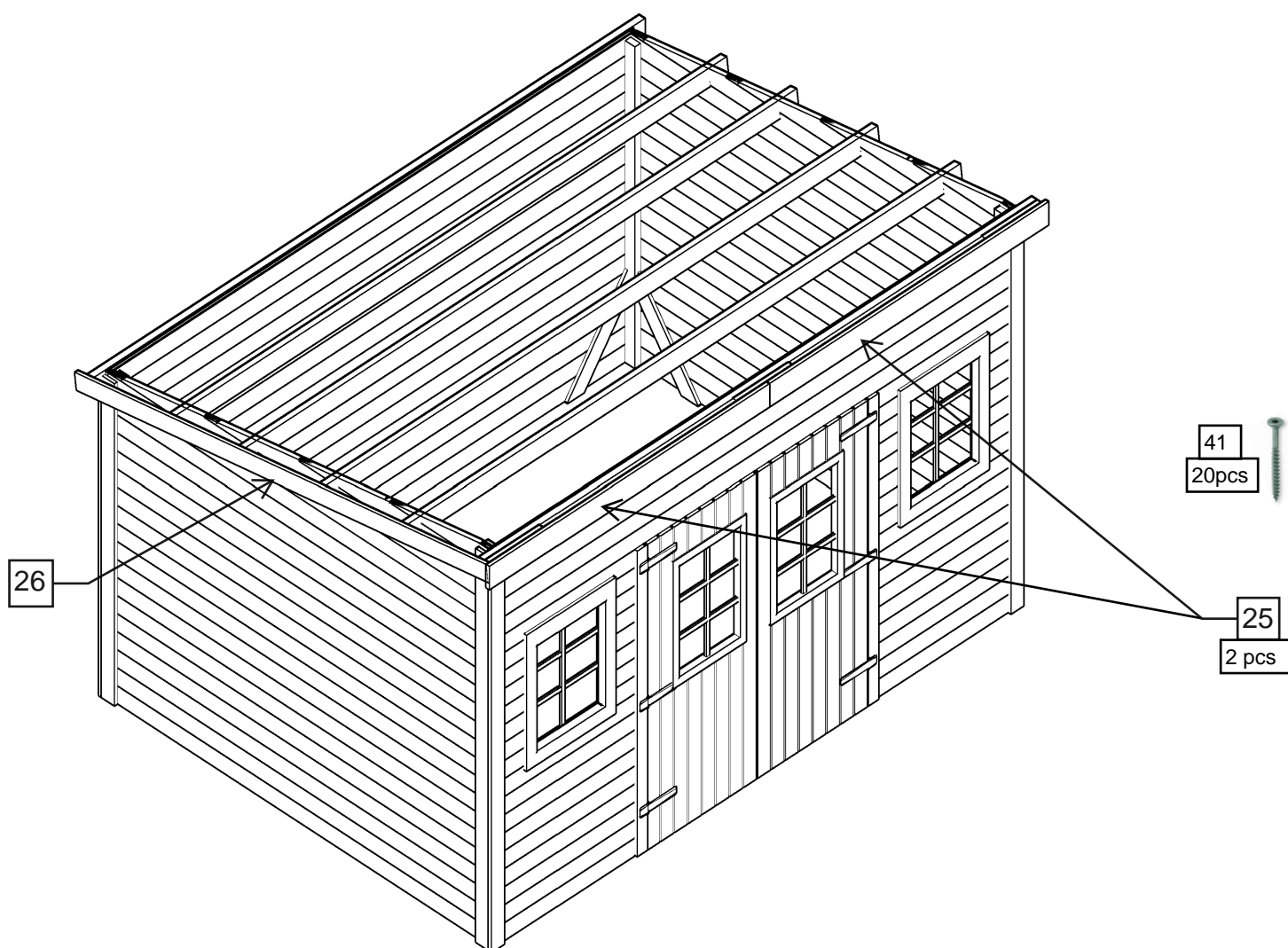

NOTICE DE MONTAGE

LA 4040 B

8/16

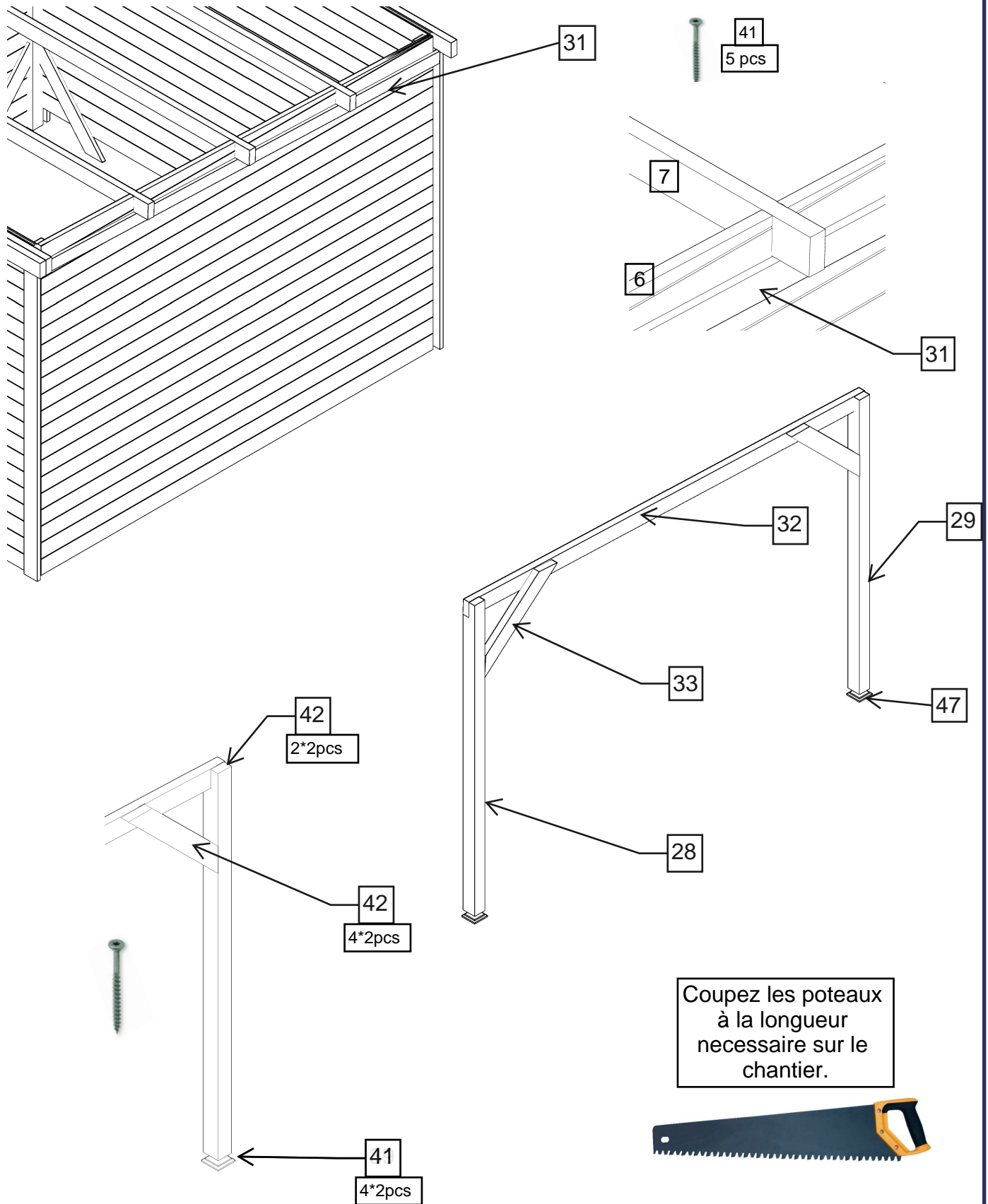

LA 4040 B

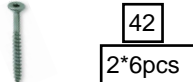
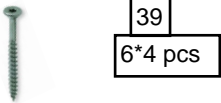
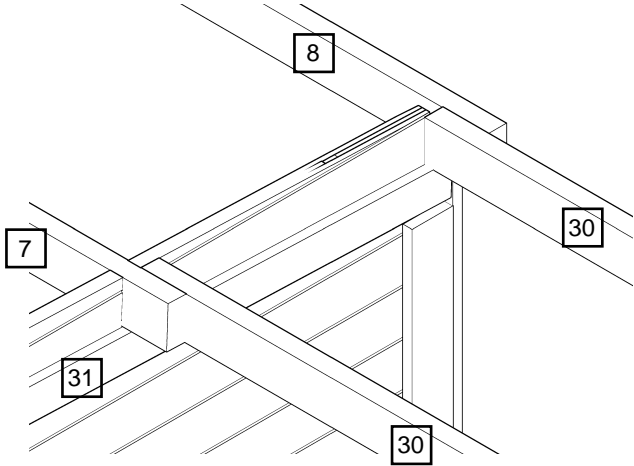
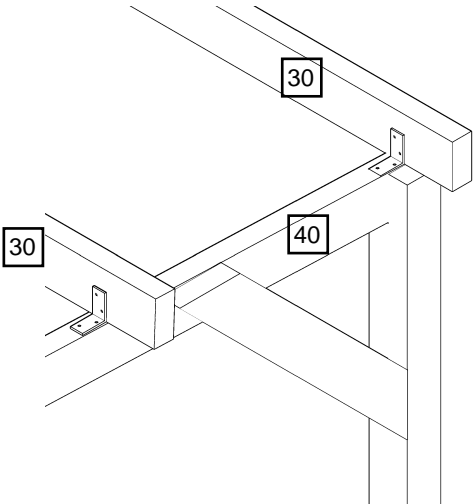
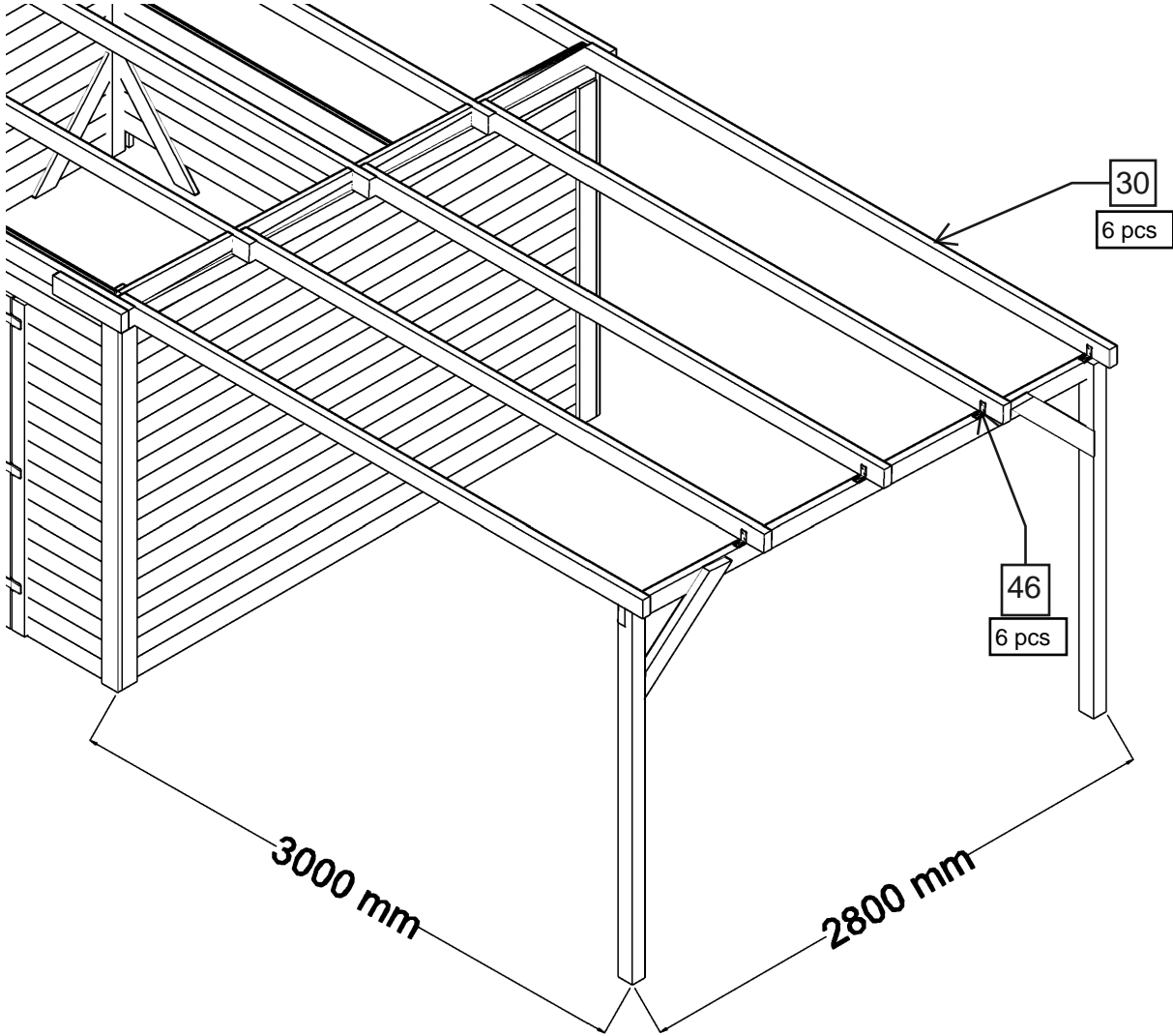

LA 4040 B

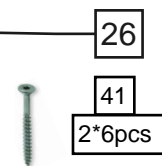
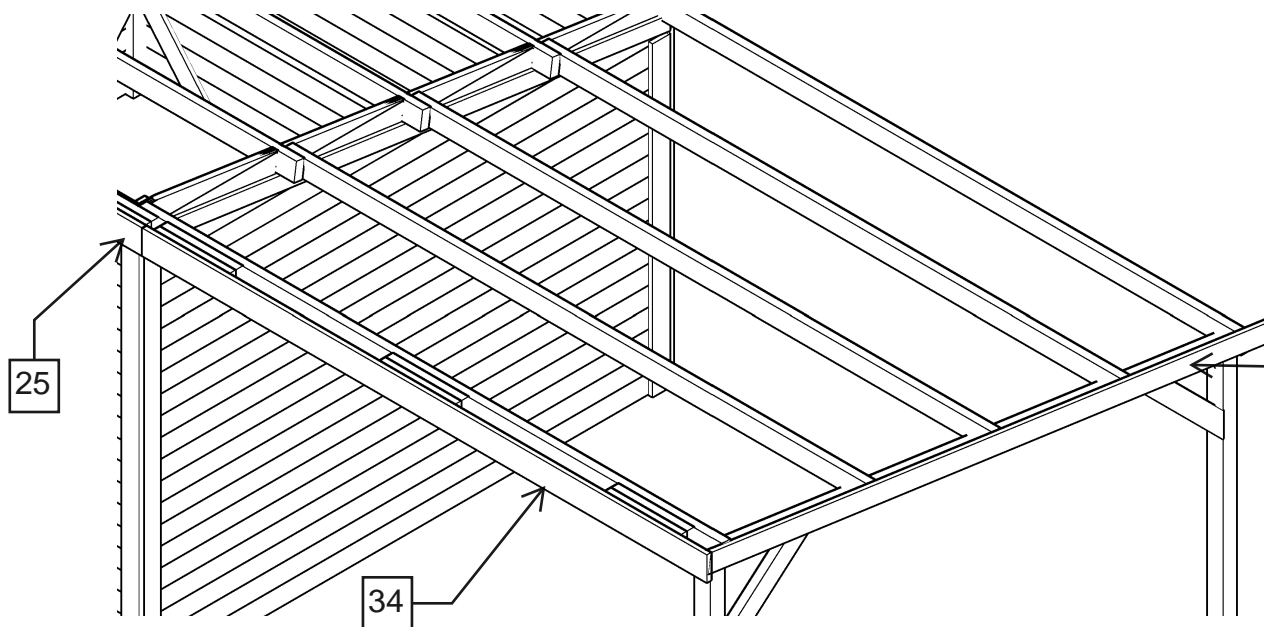
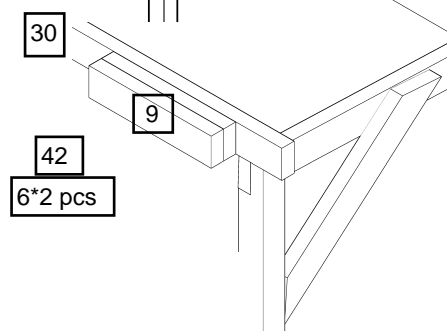
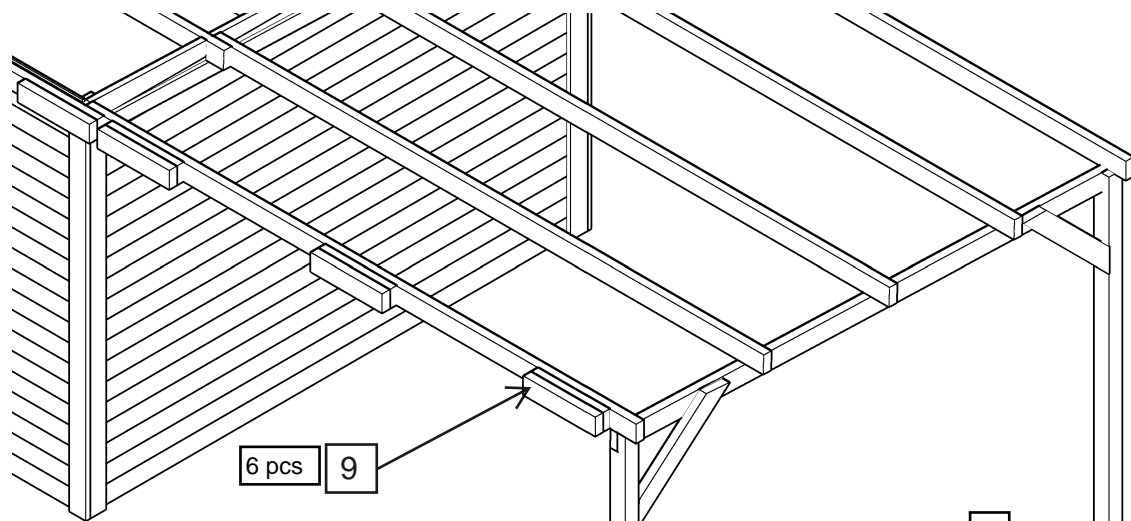



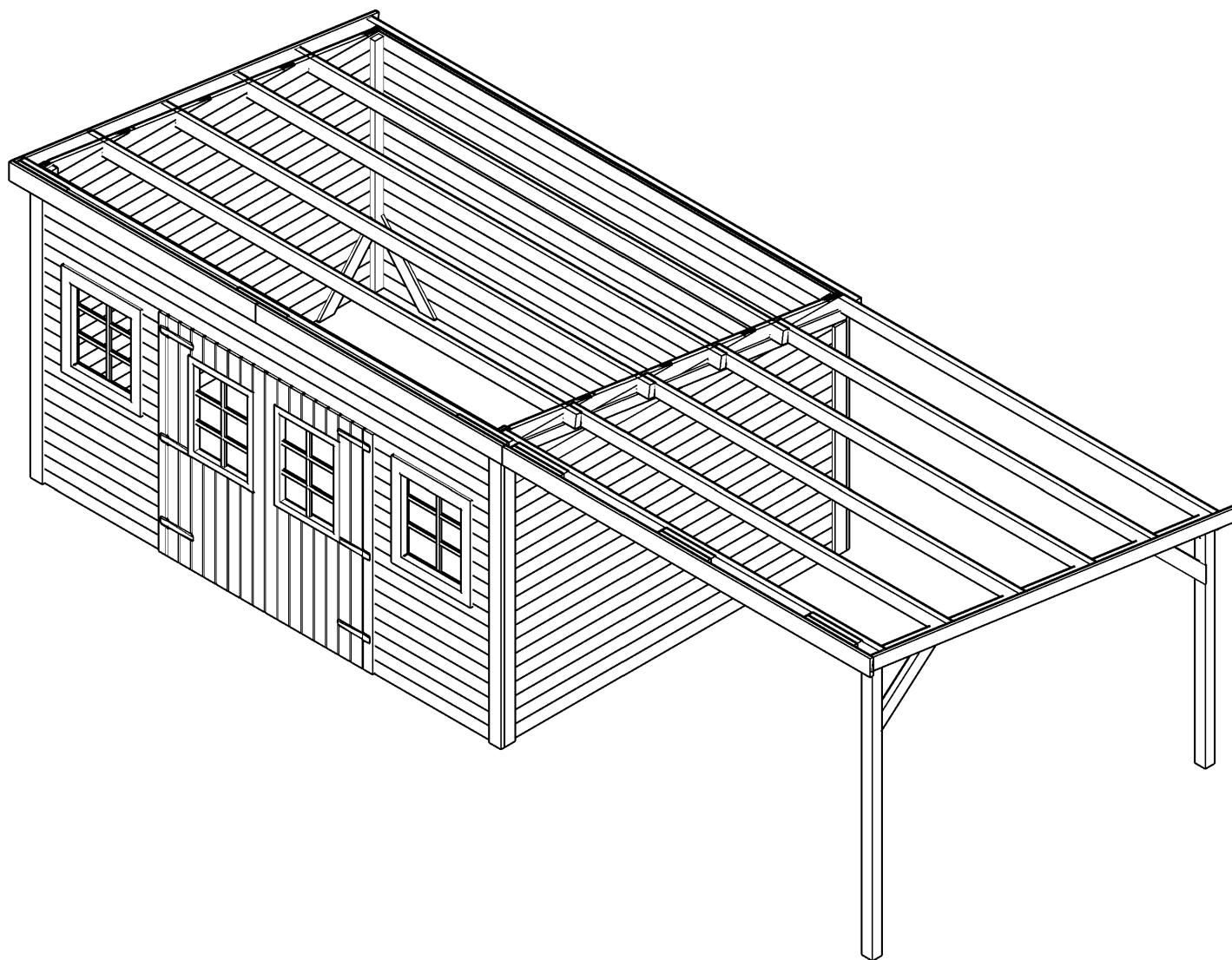

LA 4040 B

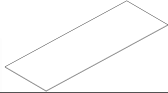

NOTICE DE MONTAGE

12/16

LA 4040 B

Nr.	Qte	Dessin pièce	Ref	Dimensions	Observation	Qte
P1.	8		POL3000.1000	4000*1000* 6		
P2.	10		PRH3000	3000* 30* 6		
P3.	8		PRU2000	2000* 20* 6		
P4.	56		VIS	4,5 * 25		

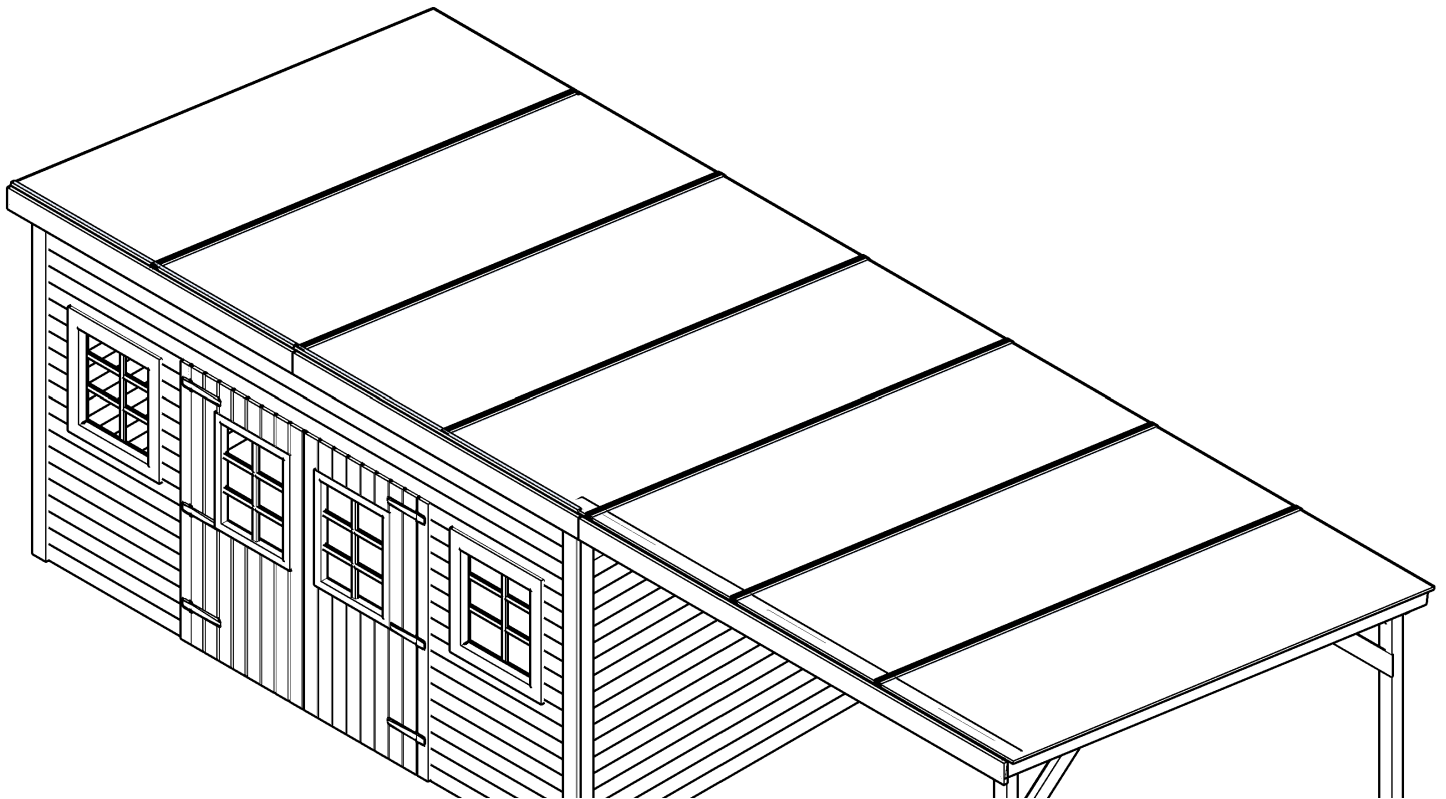

À l'aide d'un cutter, découpez une feuille de polycarbonate à une largeur de 650 mm.

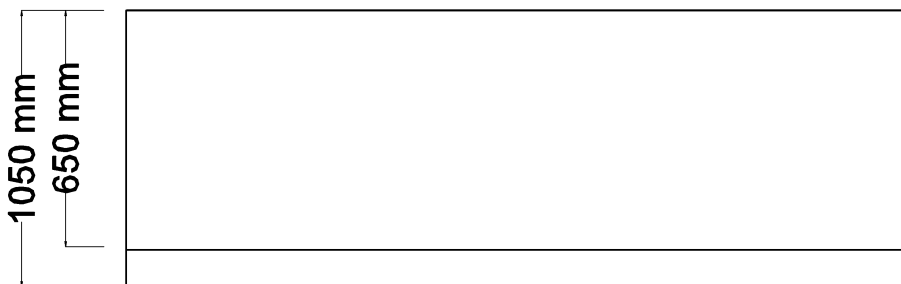

LA 4040 B

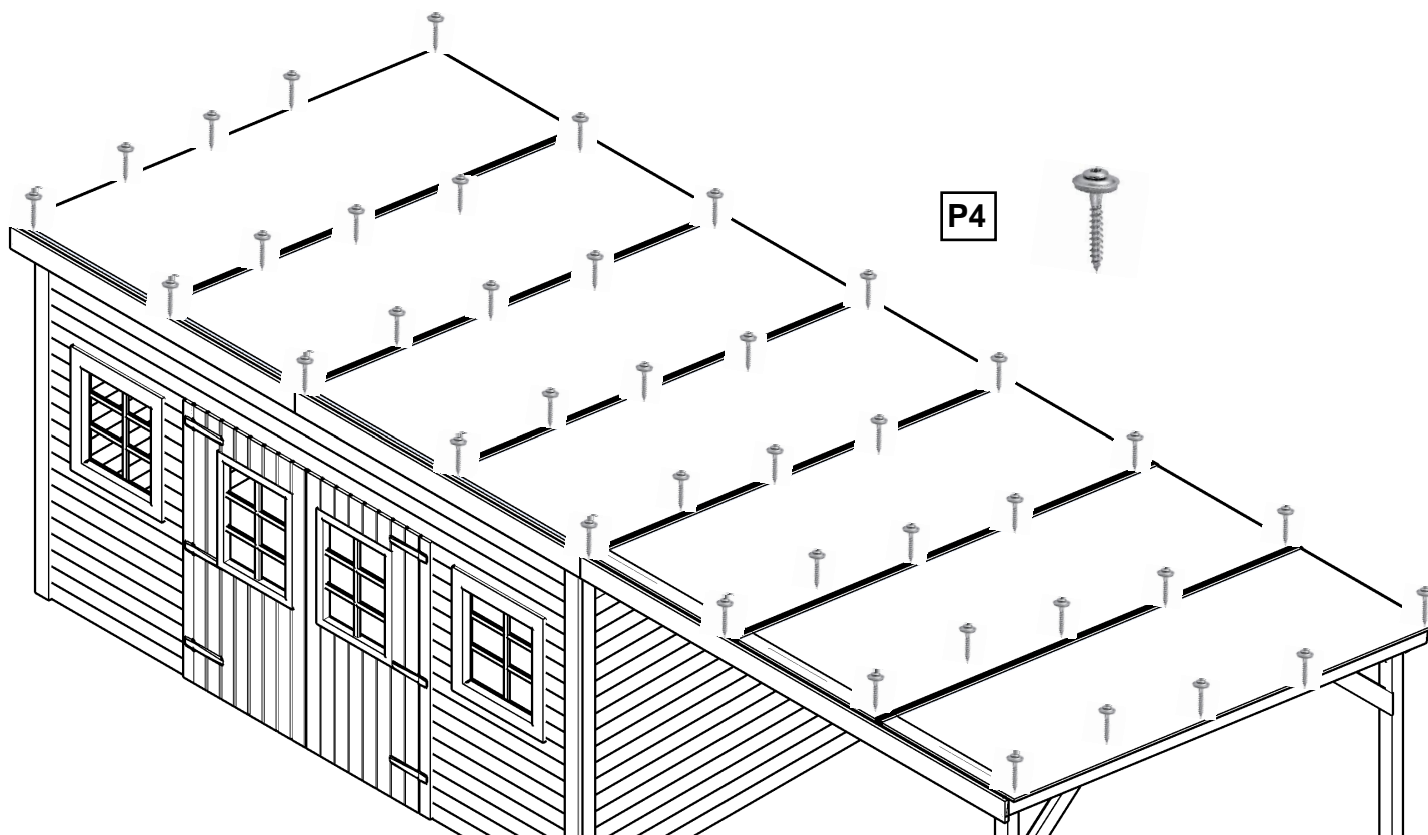
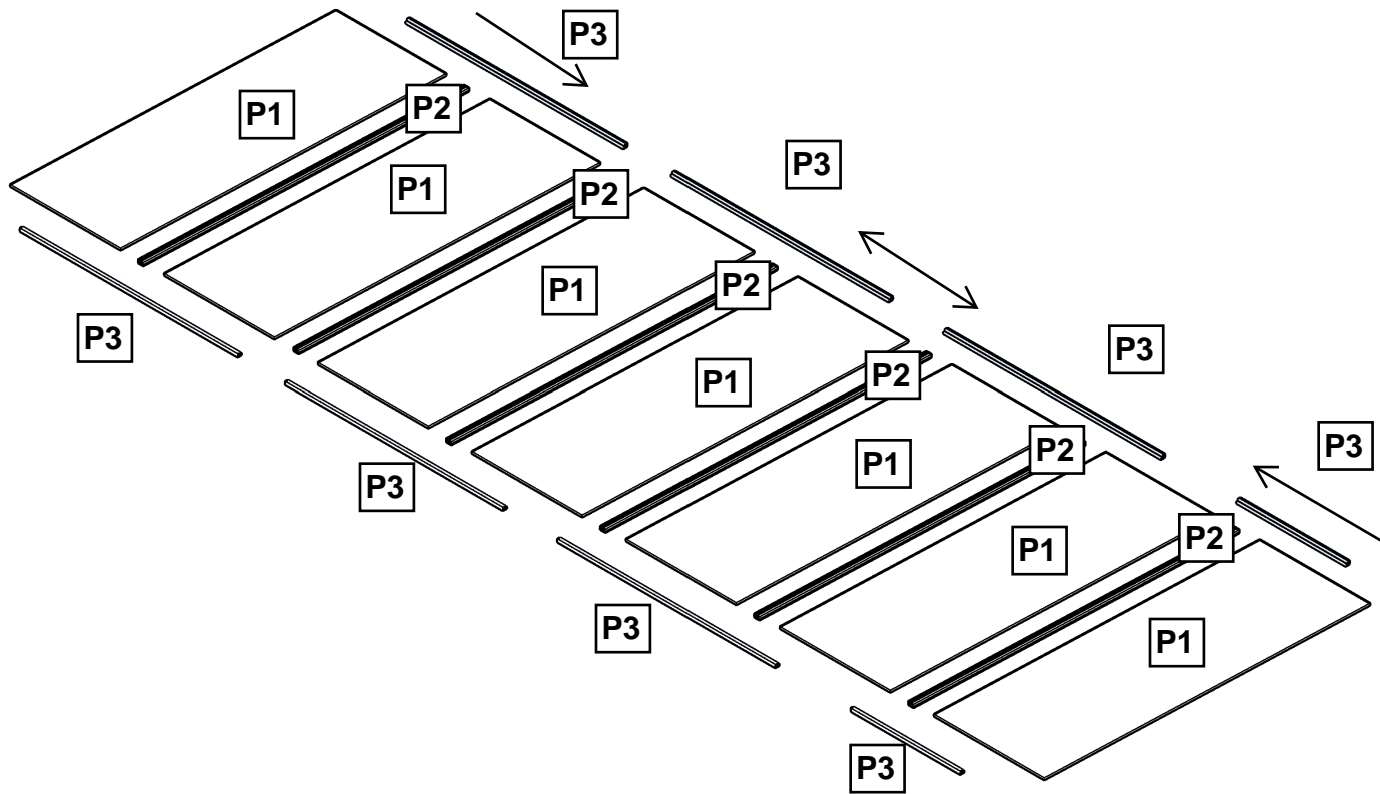

LA 4040 B

FIXATION CADRE PORTE

Vue extérieure

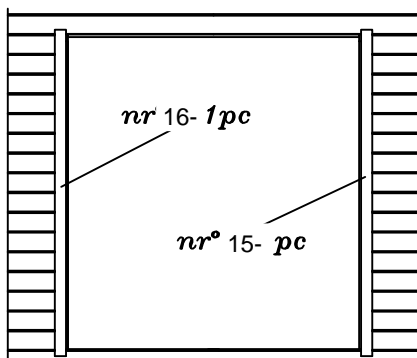

Ne pas visser les vis dans les madriers afin de les laisser travailler librement et éviter les espacements entre madriers.

Vue intérieure

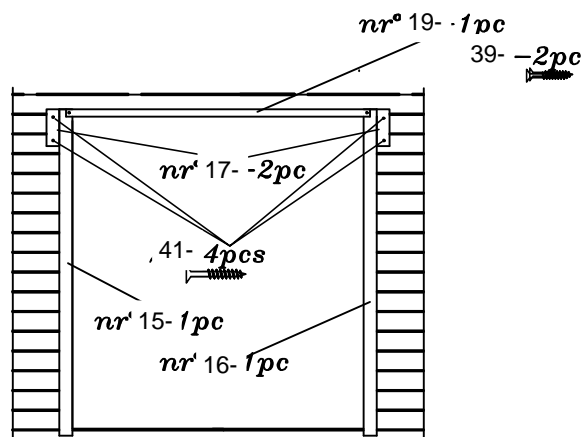

FIXATION QUINCAILLERIE ET DECORATIONS PORTE

Vue extérieure

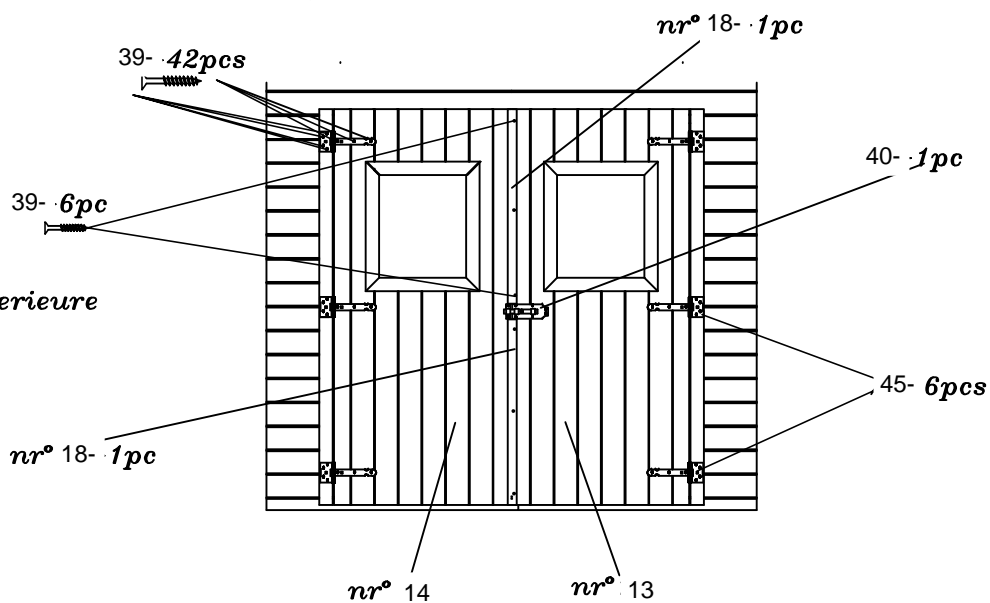

FIXATION VERROU A DOUILLE

Vue intérieure

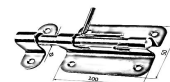
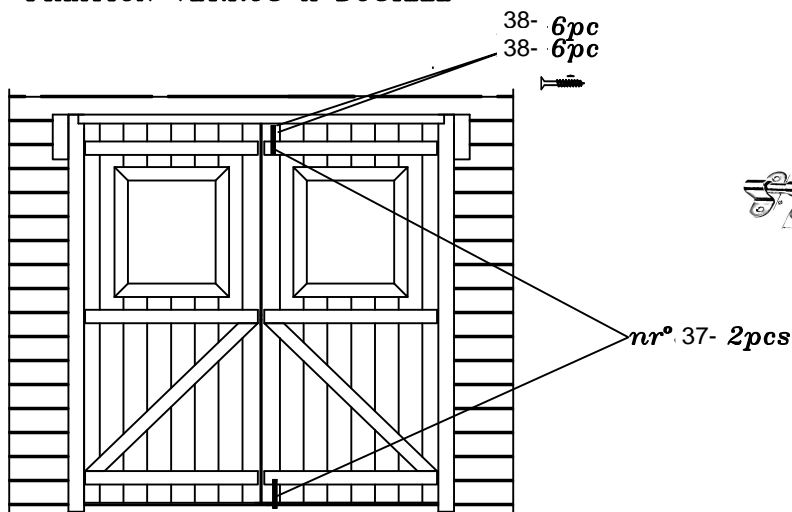

LA 4040 B

Paroi facade, vue de l'exterieur

1.	1	L28.0.3744d	3744*108* 28
2.	1	L28.0.3744d	3744*108* 28
3.	7+7	L28.0.1027	1027*108* 28
4.	5	L28.0.2744	2744*108* 28
35.	32	L28.0.228	228*108* 28

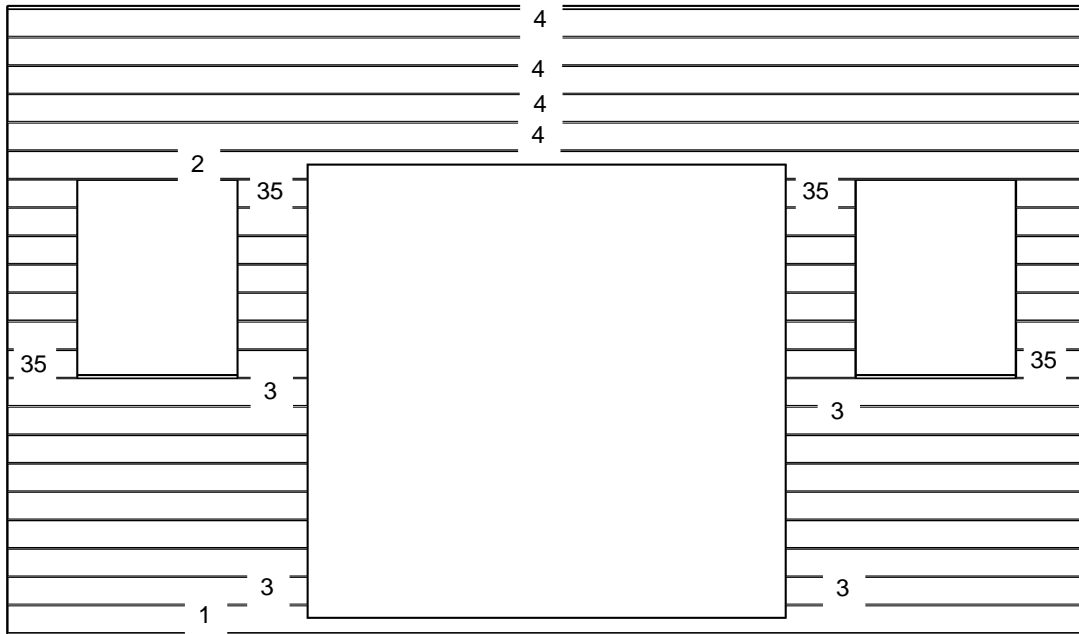

Paroi arriere, vue de l'exterieur

4.	18	L28.0.3744	3744*108* 28
----	----	------------	--------------

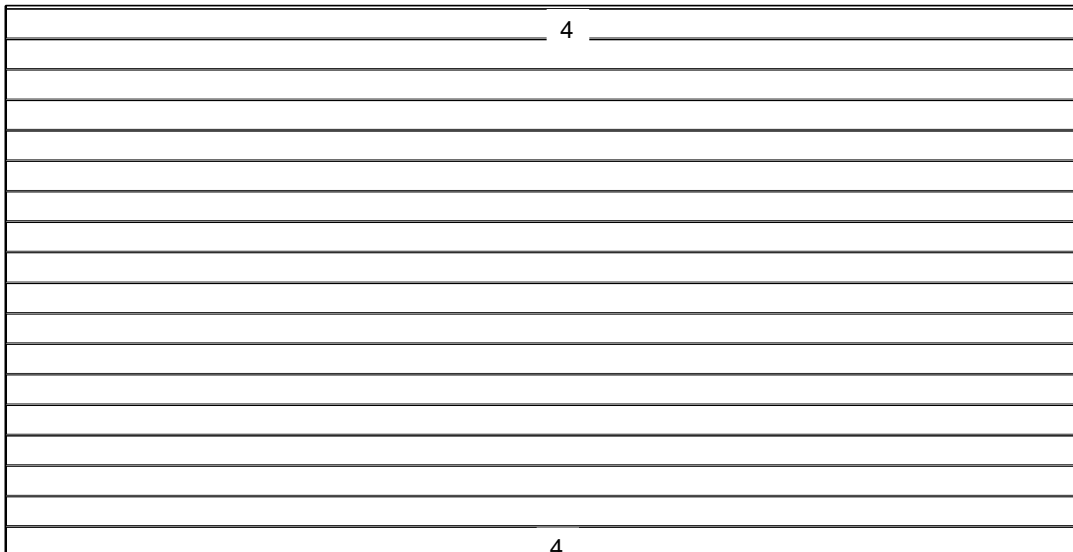

LA 4040 B

Paroi laterale, vue de l'exterieur

5.	17+17	L28.0.3744	3744*108* 28
----	-------	------------	--------------

6.	1+1	F3744.500	3744*500* 28
----	-----	-----------	--------------

