

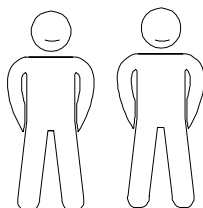

NOTICE DE MONTAGE
NAN 3535.02 N

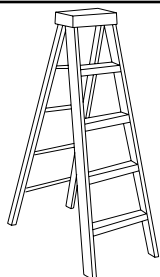
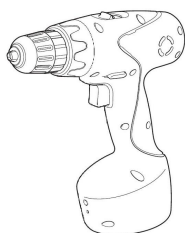
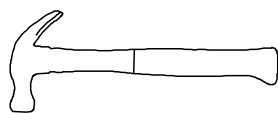
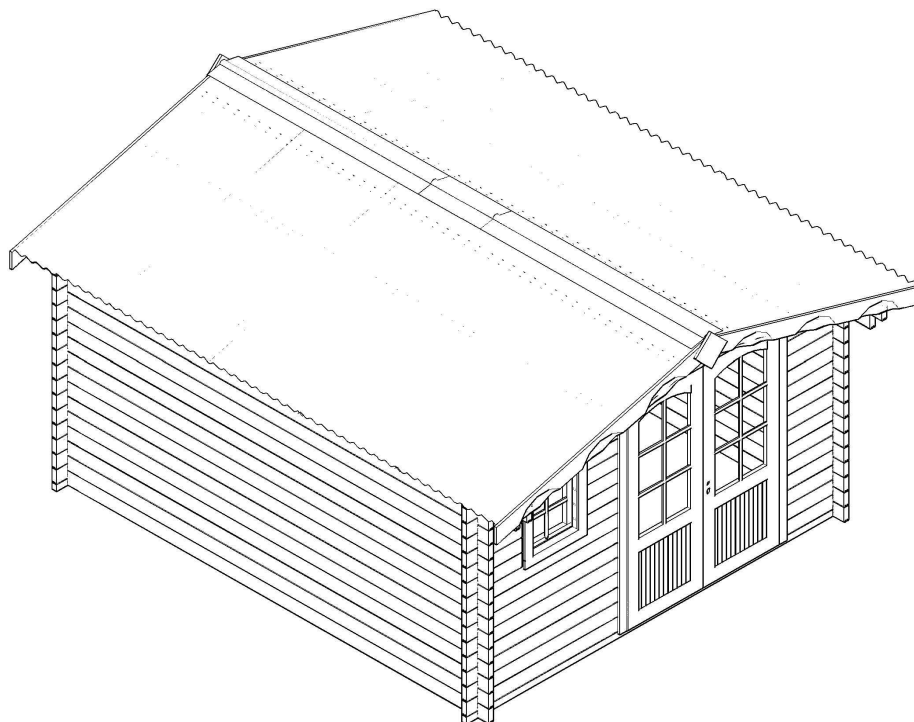
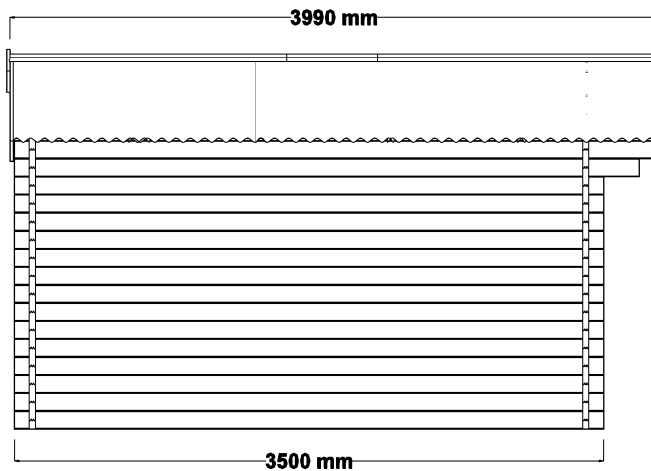
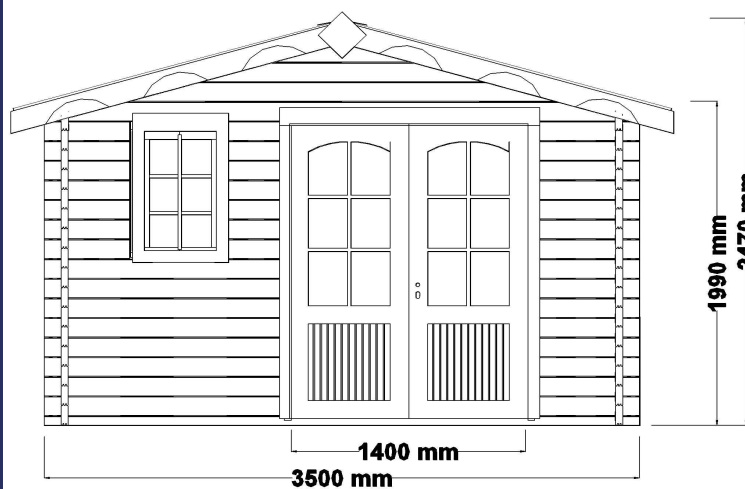

ATTENTION!!!
Pour éviter d'abîmer
vos pièces de bois, il
faut les pré-percer
avant de visser.

NAN 3535.02 N

Code EAN :

Colis n° :
**(à rappeler impérativement pour
toute demande SAV)**

maj 11.11.2025

PLAN DE SOUBASSEMENT

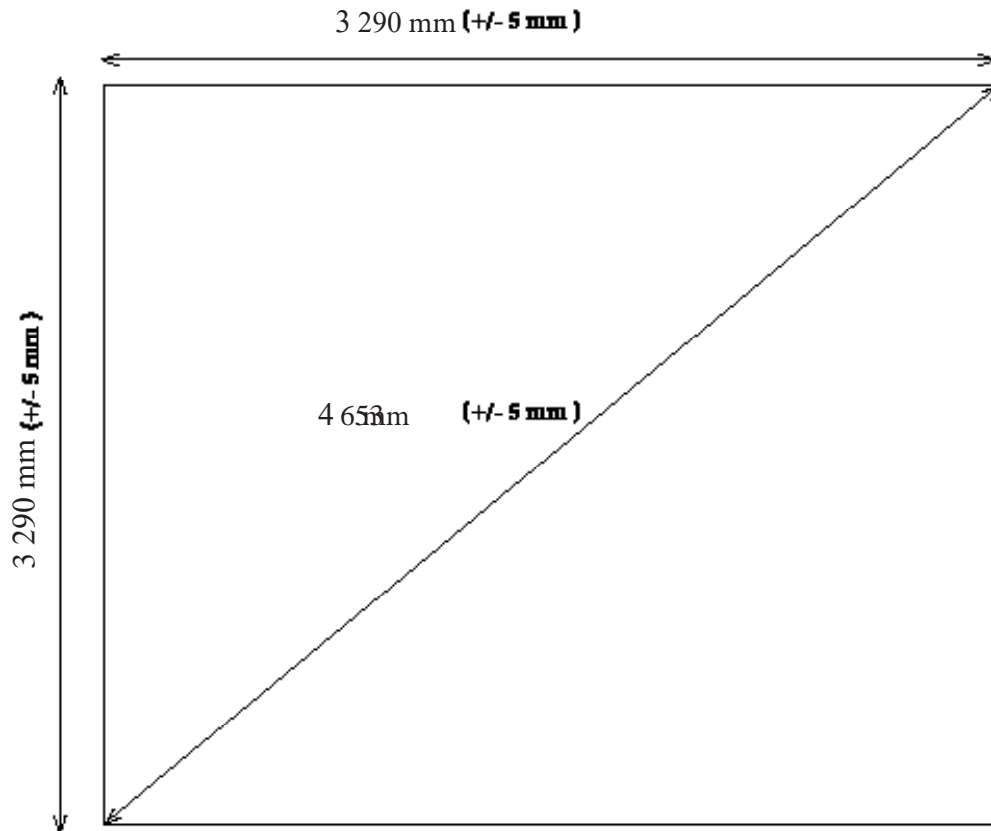

Les dimensions données sur le plan de soubassement sont les dimensions de la dalle béton à réaliser sur un sol parfaitement plat sans aucun autre objet extérieur type mur, clôture ou arbre dans l'entourage de la dalle. Si le produit est implanté près d'un mur, d'une haie ou d'un arbre il est nécessaire de l'éloigner des éléments extérieurs afin de pouvoir facilement le monter et l'entretenir. Nous nous dégageons de toute responsabilité en cas de mauvaise interprétation des dimensions de la dalle.

Le dimensioni del piano di base sono le dimensioni della soletta di cemento da realizzare su un terreno perfettamente piatto, senza alcun altro oggetto esterno, come un muro, una recinzione o un albero in prossimità delle soletta. Se il prodotto è installato vicino ad una parete, un recinto o un albero, è necessario distanziarlo adeguatamente, in modo da poterlo facilmente montare e farne la manutenzione. Non ci assumiamo alcuna responsabilità per l'errata interpretazione delle dimensioni delle lastra.

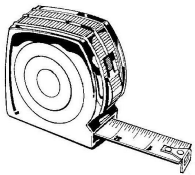

Tolérances à respecter (selon DTU 31.2):

- longueur et largeur: + 0,01m;
- équerrage: +0,01m mesuré sur 10m;
- arase: +0,01m sur une longueur de 10 mètres linéaires alignés ou non et de + 2mm par mètre linéaire;
- rectitude de bords en plan: +5mm .

NOTICE DE MONTAGE



















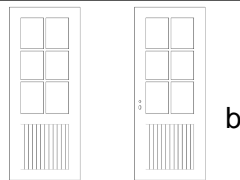

3

NAN 3535.02 N

Nous garantissons la fourniture des pièces détachées durant 2 ans à compter de l'achat du produit.

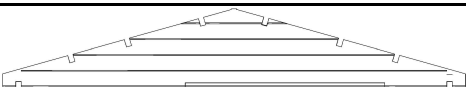
Vérifier que vous avez bien toutes les pièces avant d'effectuer le montage

Demande SAV











Nr.	Qte	Dessin pièce	Ref	Dimensions	Observation	Qte
1.	2		I42.2.3500	3500* 65* 42		
2.	7		L42.1.575	575*130* 42		
3.	8		L42.1.1525	1525*130* 42		
4.	7		L42.0.435	435*130* 42		
5.	28		L42.2.3500	3500*130* 42		
6.	15		L42.2.3500	3500*130* 42		
7.	15		L42.1.495	495*130* 42		
8.	1		TLS1845.42	1835* 80* 90		
9.	1		TLD1845.42	1835* 80* 90		
10.	1		TS1550.42	1550*120* 90		
11.	a		US1800.42	1800*700* 28		
	b		UD1800.42	1800*700* 28		
12.	1		SA1800.70	1800* 70* 20		
13.	1		F595.910.42	595*910* 90		
14.	2		L42.2.3740	3740*130* 42		
15.	1+1		LS42.2.3950	3950*190* 42		
16.	6		GL3450.90	3450* 90* 40		
17.	1+1		F42.3500.600	3500*600* 62		
18.	10		OND2000.860	2000* 860* 30		
20.	3		FON1500.490	1500*490* 30		
21.	200		Clous ond			

maj 11.11.2025

NOTICE DE MONTAGE

NAN 3535.02 N

4

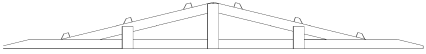
Nr.	Qte	Dessin pièce	Ref	Dimensions	Observation	Qte
22.	2		ELT200.70	200* 70* 20		
23.	4		DSF2050.90	2050* 90* 20		
24.	2		R200.100	200*100* 20		
25.	12		ClouL100			
26.	20		ClouL16			
27.	8		Vis3.0*30			
28.	6		Vis3.5*35			
29.	38		Vis4.5*45			
30.	2		Verrou a douille			
31.	1		Serrure a barillet			
32.	1		FI80.3500.452	3500*452* 80		

A compléter impérativement pour toute demande SAV et à envoyer par mail à sav@foresta.fr + photo des pieces abimes (To be completed imperatively + Photo of damaged parts)

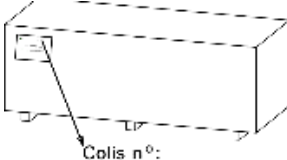
 <p>Colis n°: _____</p>	AN535.02 N Colis(package) n° :	MAGASIN (STORE)	
		NOM (NAME) CLIENT	
		PRENOM(PRE.) CLIENT	
		N° de téléphone (PHONE)	

maj 11.11.2025

NOTICE DE MONTAGE
NAN 3535.02 N

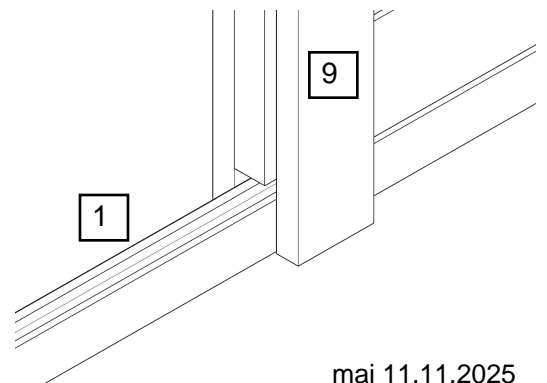
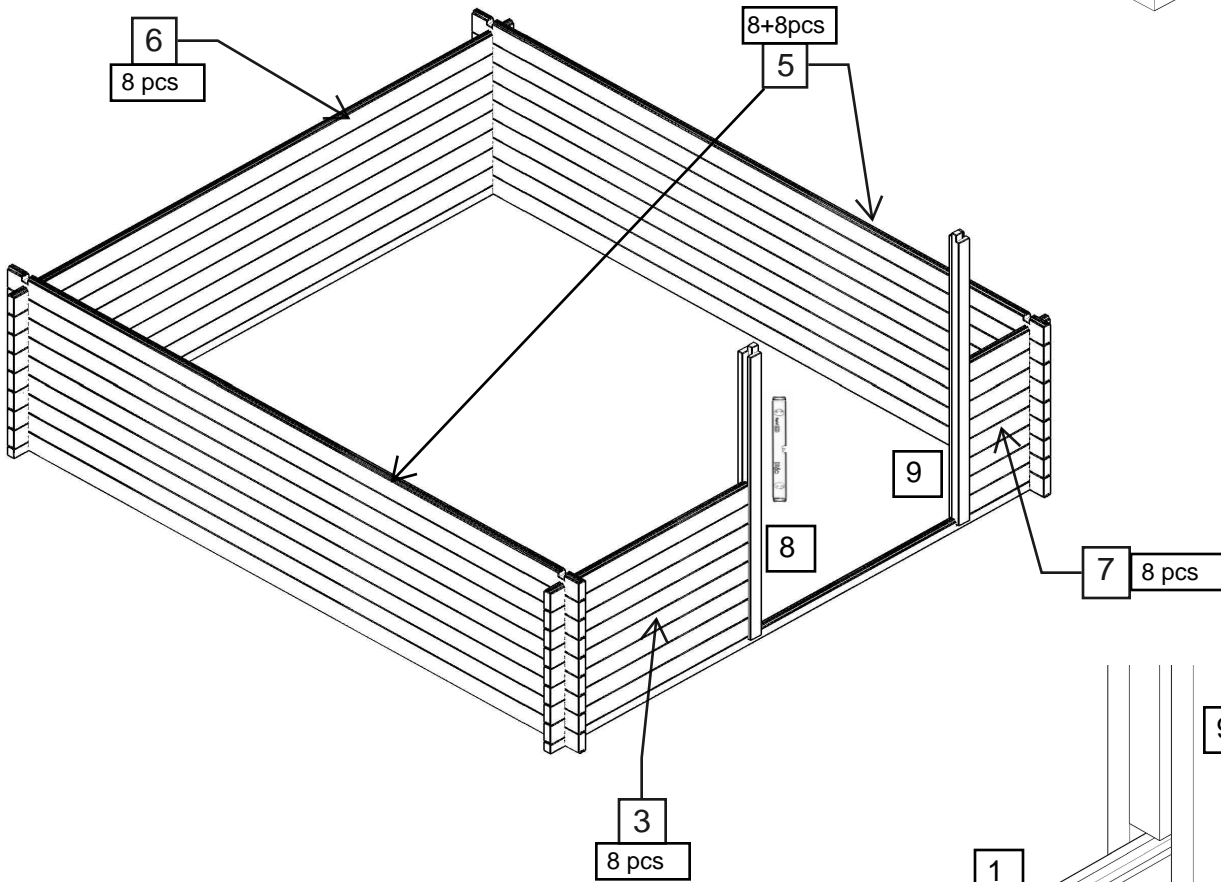
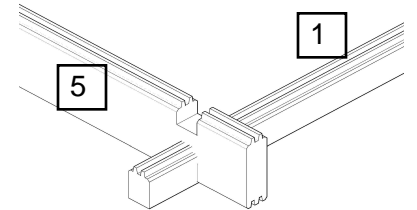
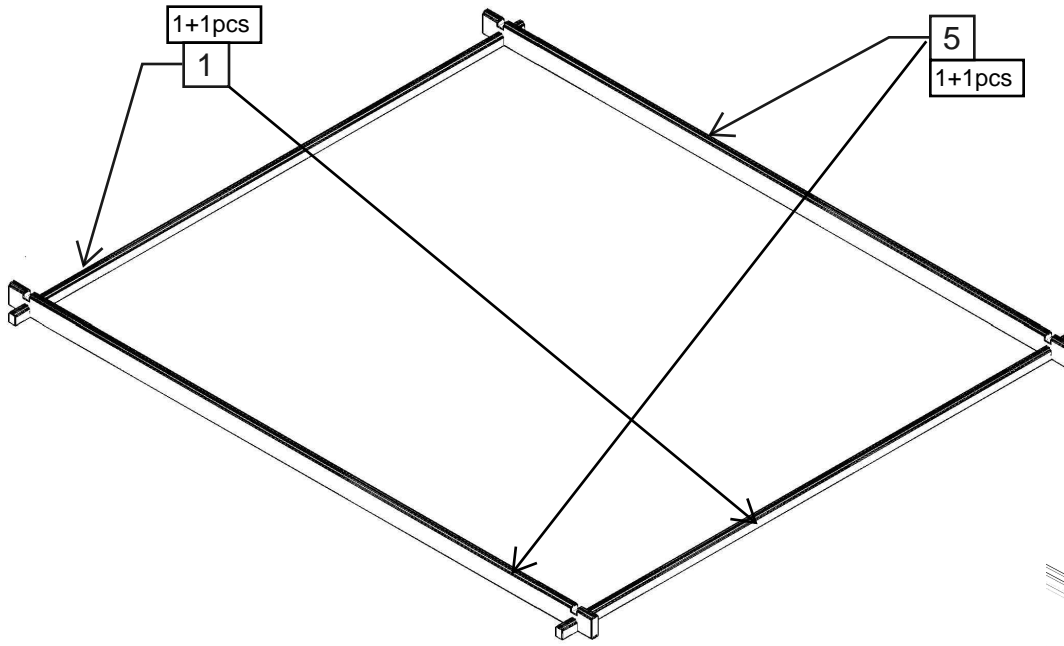

NOTICE DE MONTAGE

NAN 3535.02 N

6

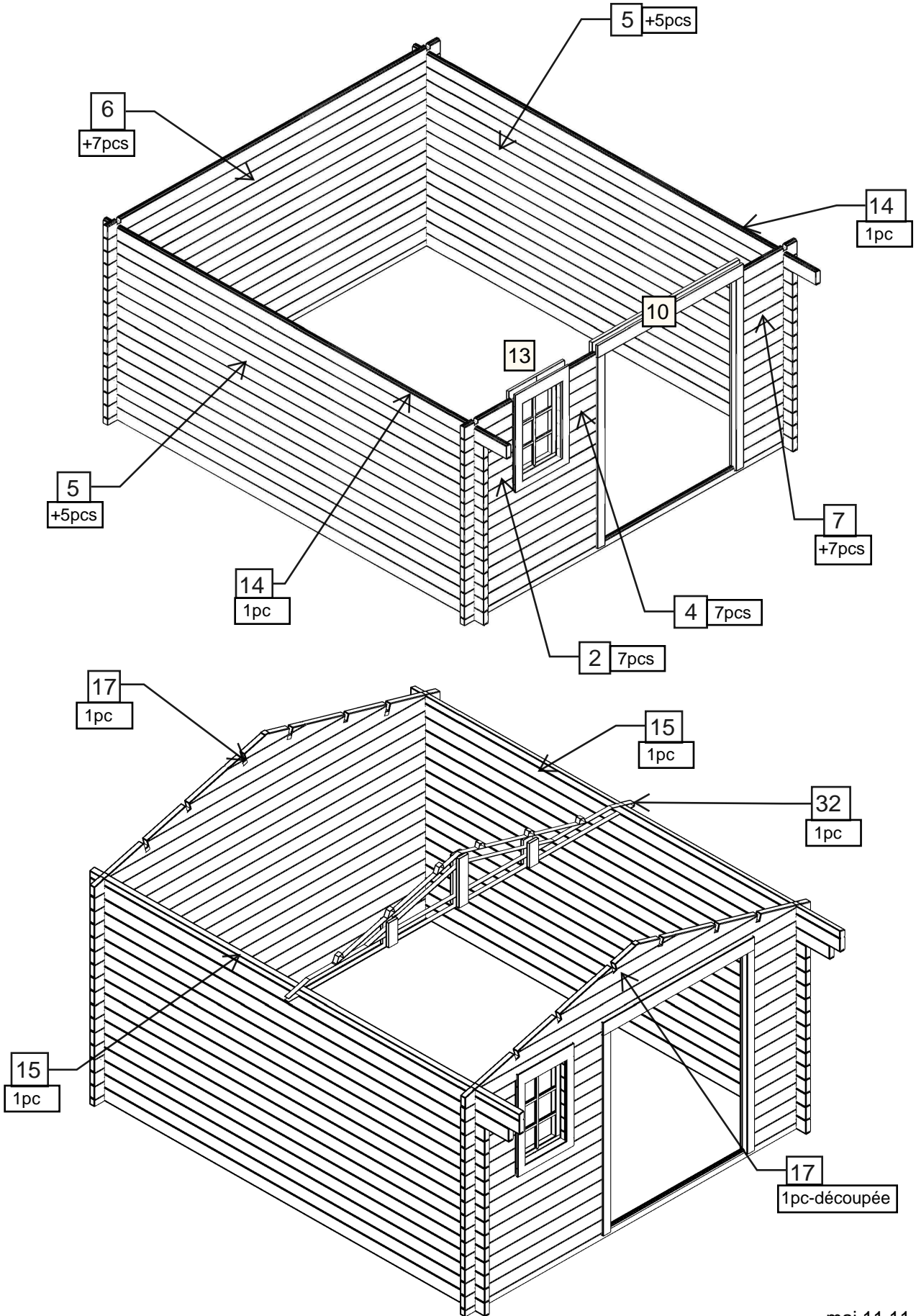

NOTICE DE MONTAGE

NAN 3535.02 N

7

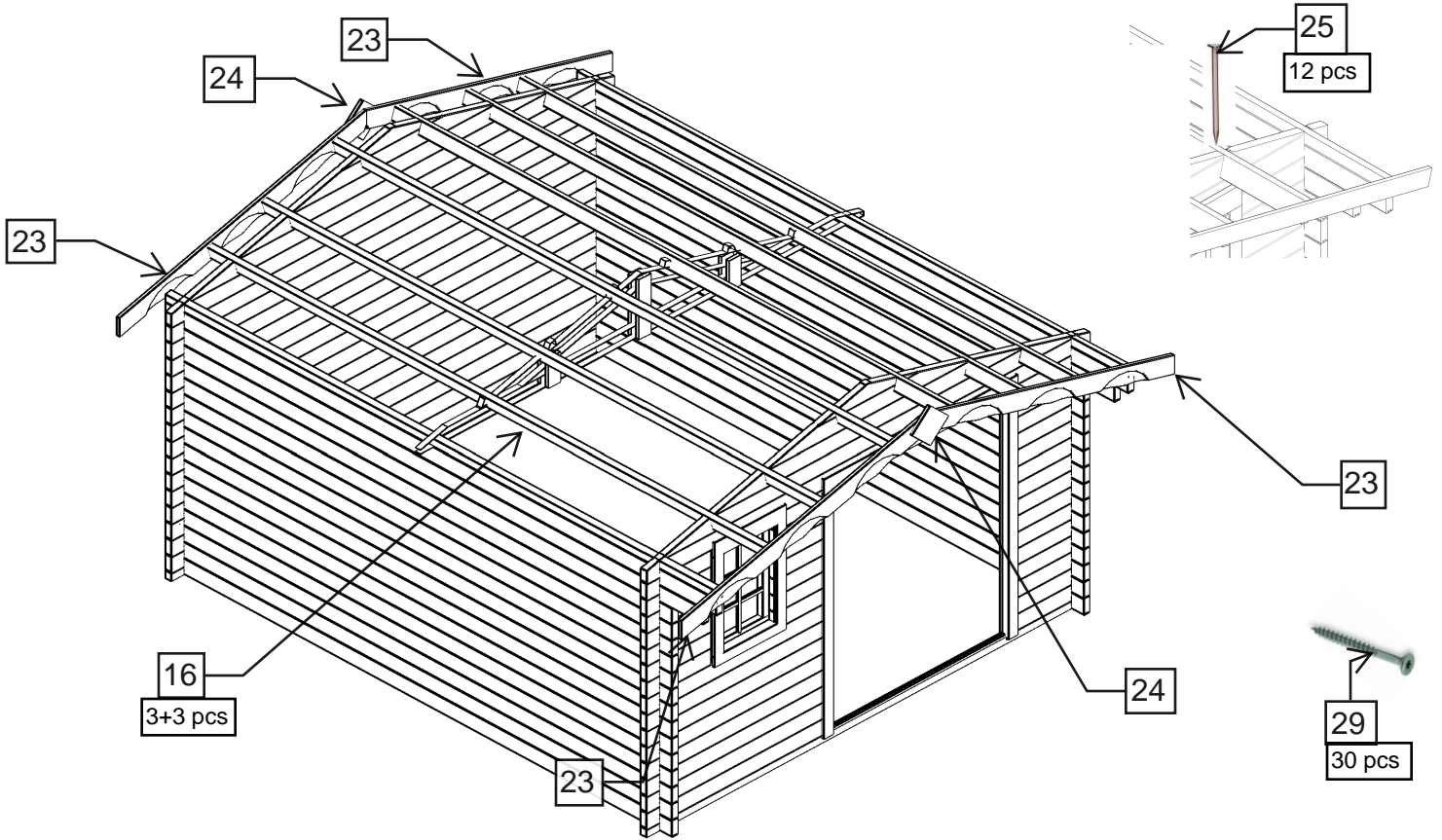

Installer les décorations n ° 23 puis commencer à positionner les plaques ondulées en commençant par l'avant et l'arrière en fixant les plaques sur les décorations n ° 23 avec des clous n ° 26.

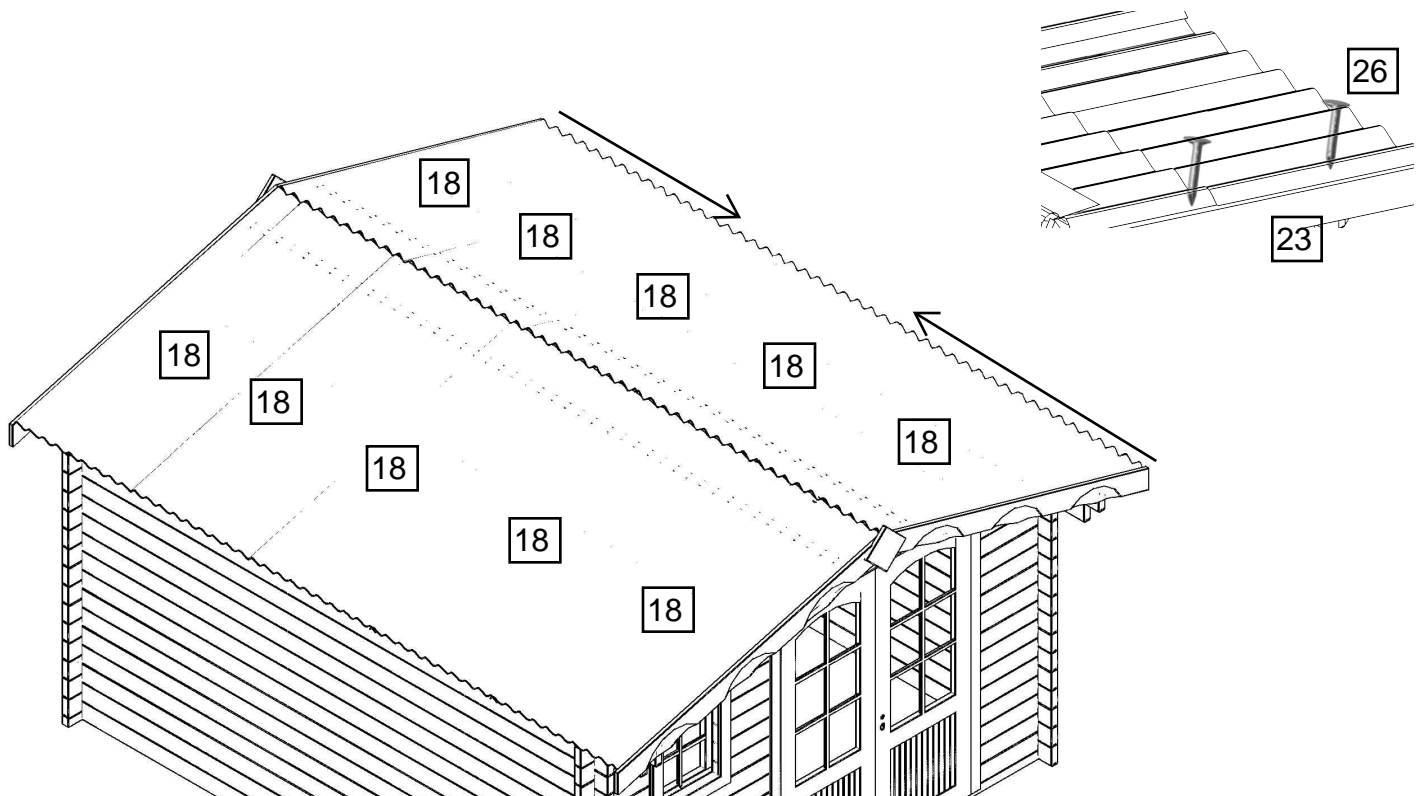

maj 11.11.2025

NOTICE DE MONTAGE

NAN 3535.02 N

8

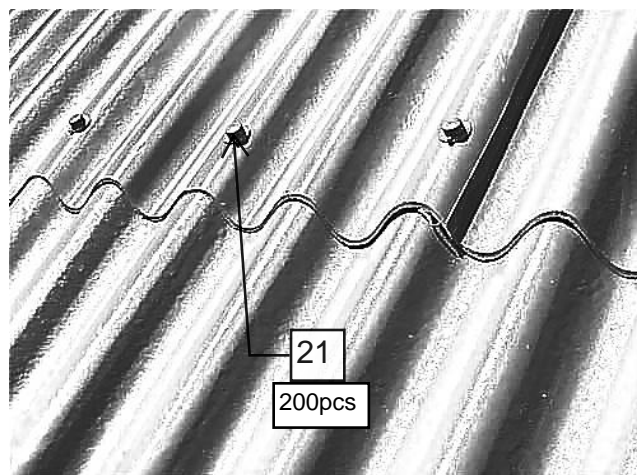

Fixer les clous une ondulation sur deux!

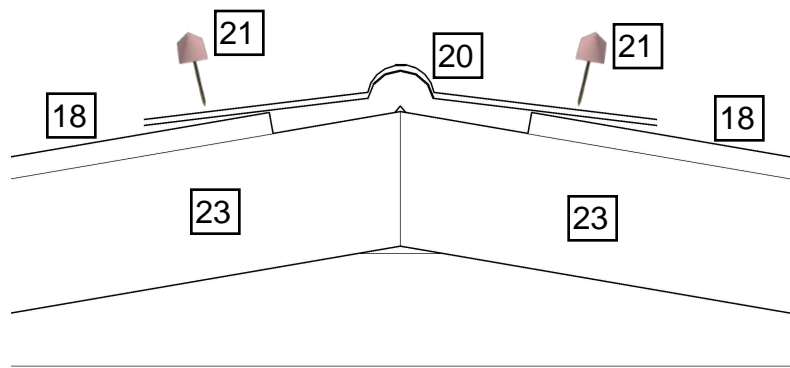
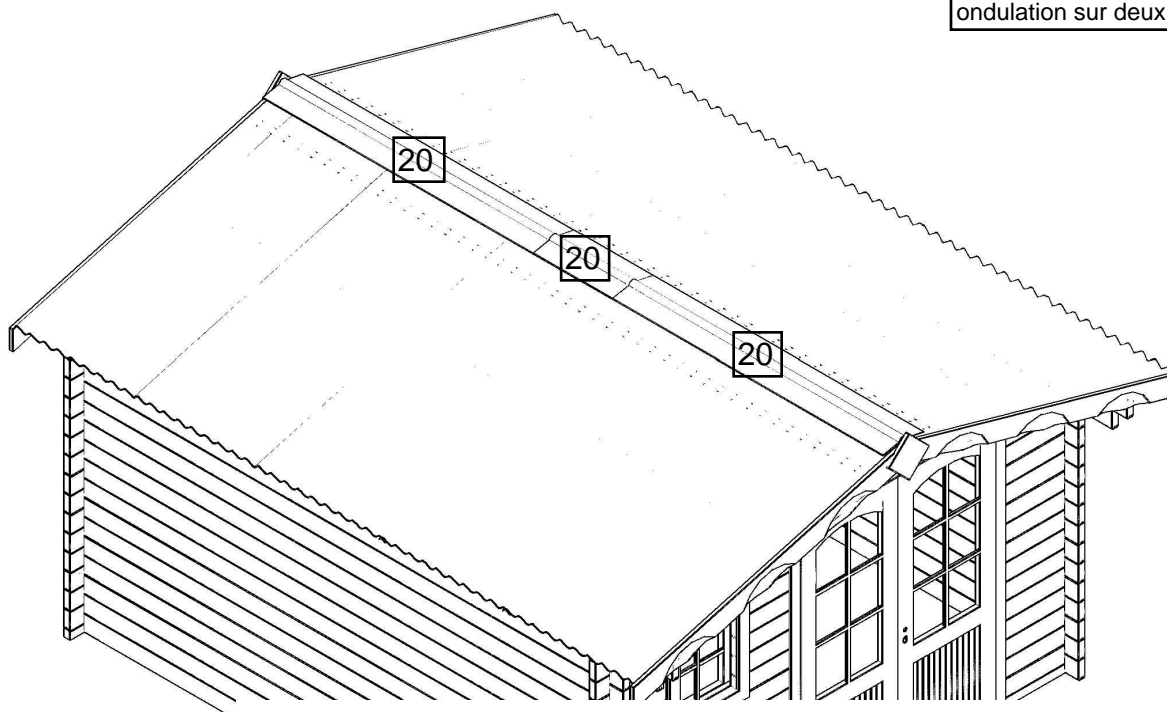

FIXATION CADRE PORTE

Vue extérieure

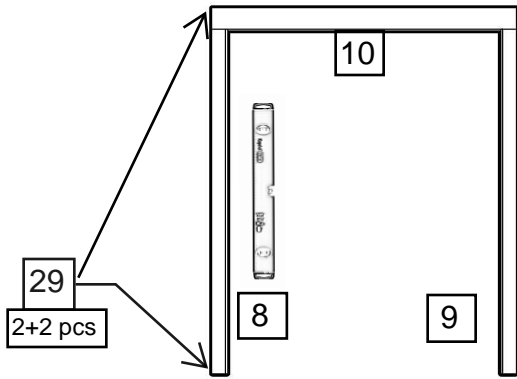

Vue intérieure

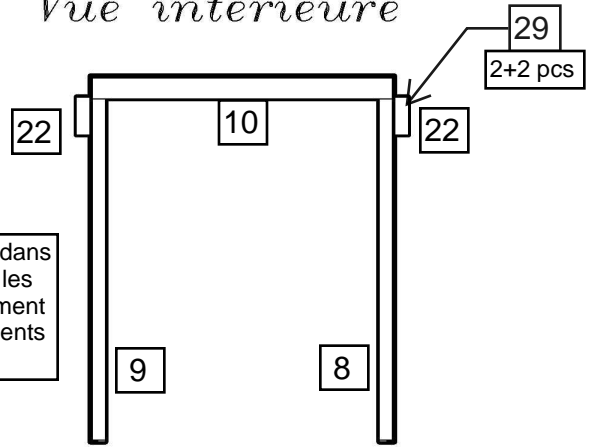

Ne pas visser les vis dans les madriers afin de les laisser travailler librement et éviter les espaces entre madriers.

FIXATION DECORATION PORTE

Vue extérieure

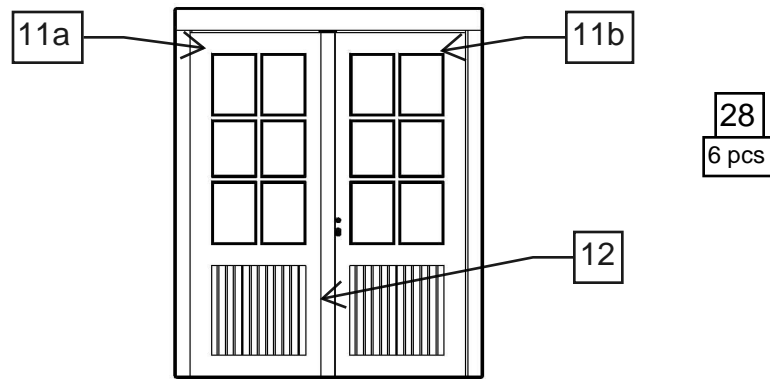

FIXATION VERROU A DOUILLE

Vue intérieure

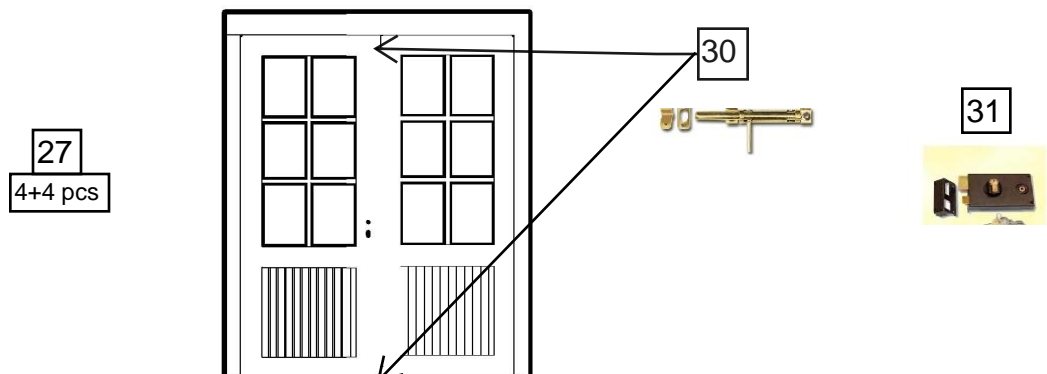

Paroi facade, vue de l'exterieur

Nr.	Qte.	Dimensions (mm)
1	1	3500 x 65 x 42
2	7	575 x 130 x 42
3	8	1525 x 130 x 42
4	7	435 x 130 x 42
7	15	495 x 130 x 42
17	1	3500 x 600 x 62
16	6	3450 x 90 x 40

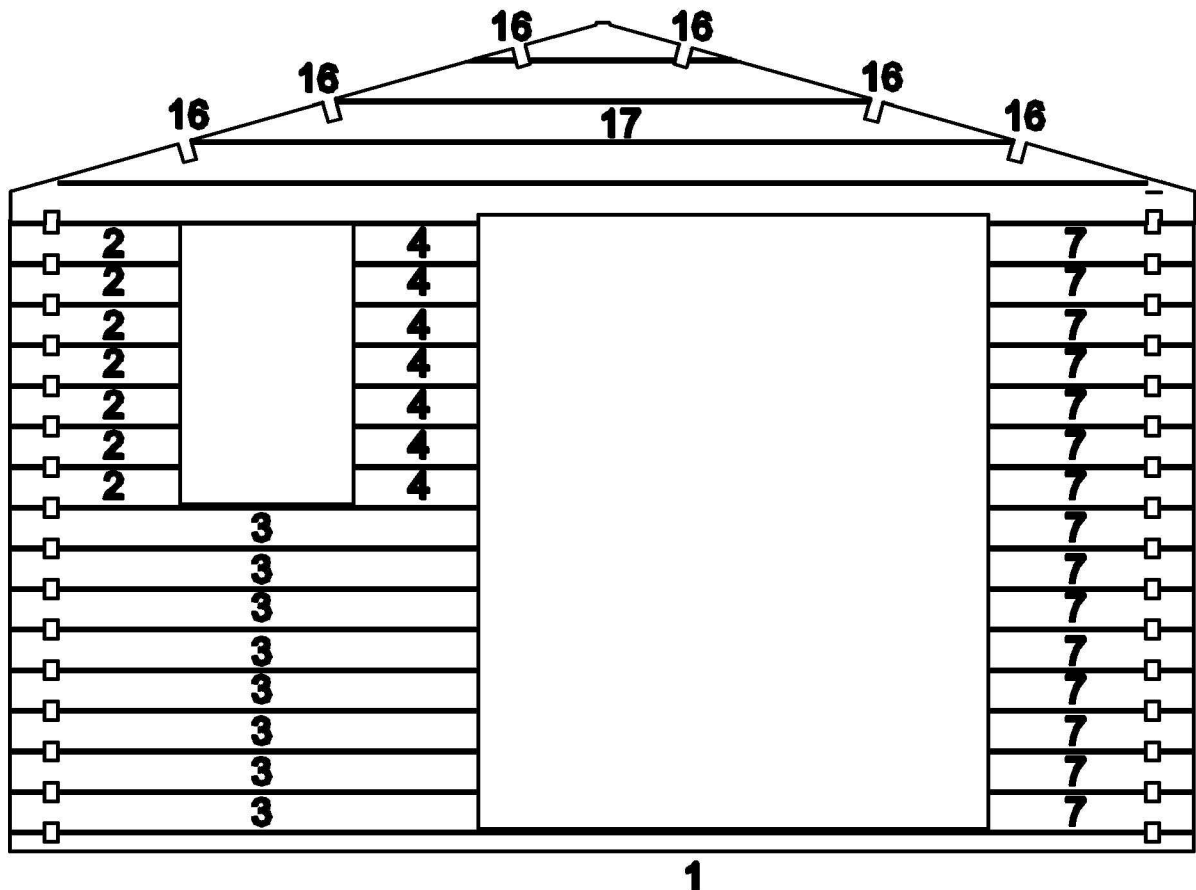

Paroi arriere, vue de l'exterieur

Nr.	Qte.	Dimensions (mm)
1	1	3500 x 65 x 42
6	15	3500 x 130 x 42
17	1	3500 x 600 x 62

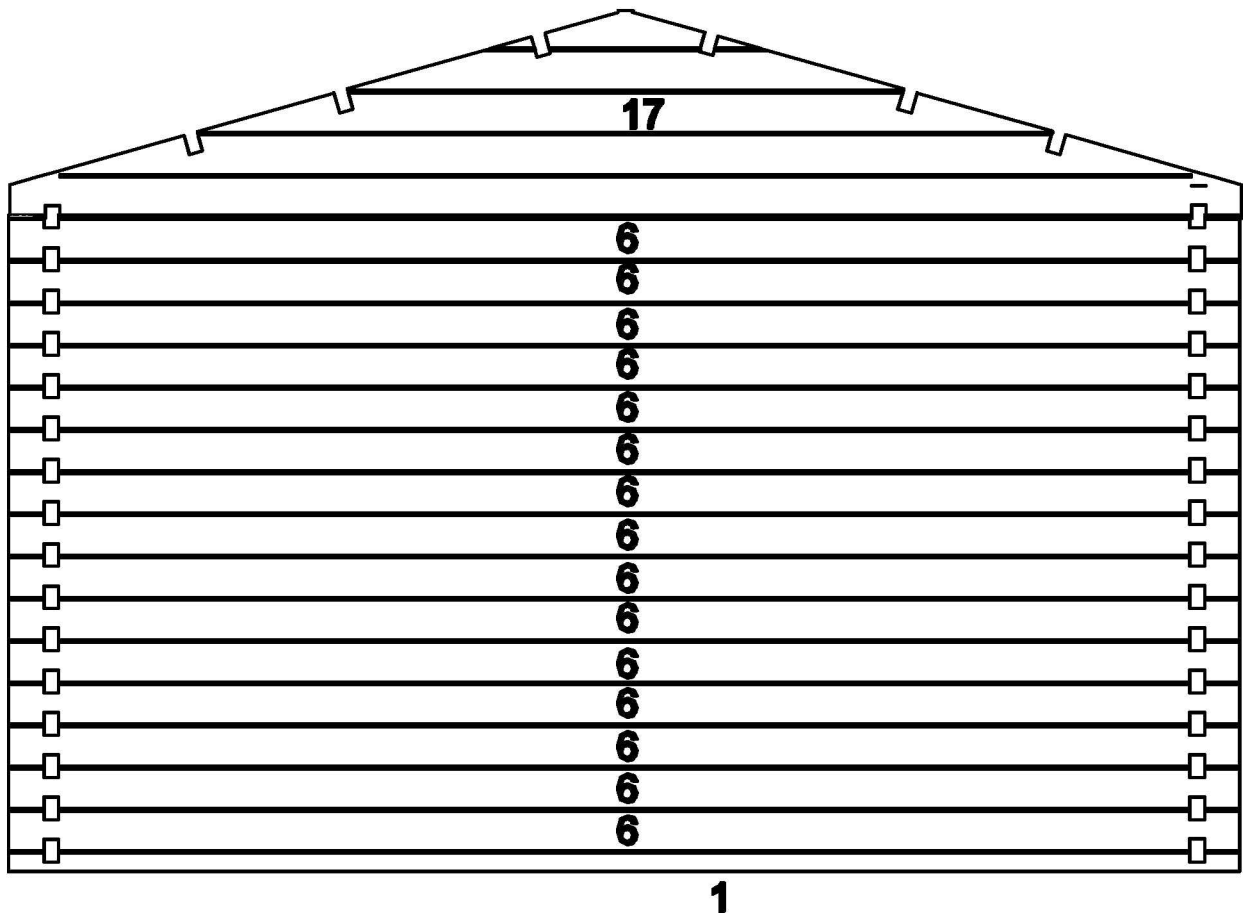

NOTICE DE MONTAGE
NAN 3535.02 N

Paroi laterale , vue de l'exterieur

Nr.	Qte.	Dimensions (mm)
5	14+14	3500 x 130 x 42
14	1+1	3740 x 130 x 42
15	1+1	3950 x 190 x 42

