

ATTENTION!!!
Pour éviter d'abîmer
vos pièces de bois, il
faut les pré-percer
avant de visser.

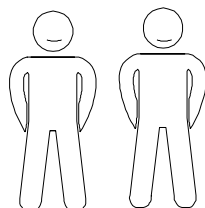
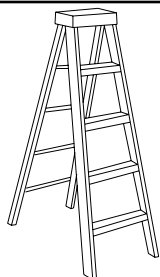

VE 3562 S

Code EAN : 3701406705243

Colis n° :
(à rappeler impérativement pour
toute demande SAV)

maj 12.01.2026

PLAN DE SOUBASSEMENT

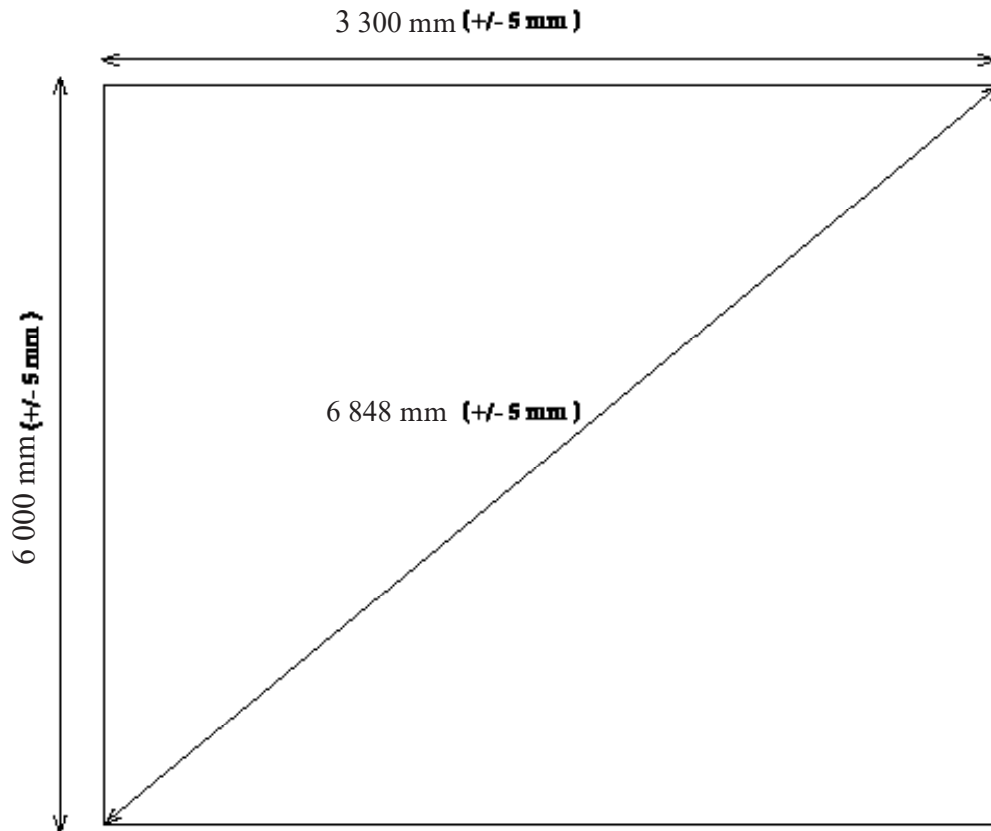





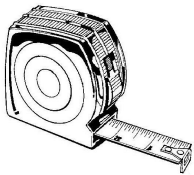



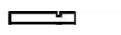
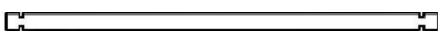
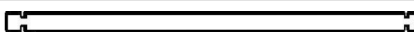
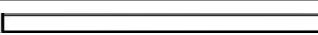
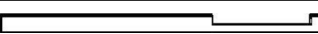

Les dimensions données sur le plan de soubassement sont les dimensions de la dalle béton à réaliser sur un sol parfaitement plat sans aucun autre objet extérieur type mur, clôture ou arbre dans l'entourage de la dalle. Si le produit est implanté près d'un mur, d'une haie ou d'un arbre il est nécessaire de l'éloigner des éléments extérieurs afin de pouvoir facilement le monter et l'entretenir. Nous nous dégageons de toute responsabilité en cas de mauvaise interprétation des dimensions de la dalle.

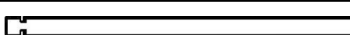

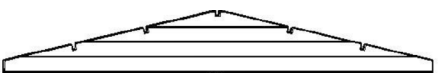
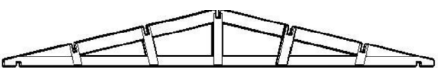
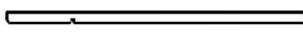
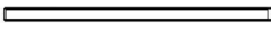
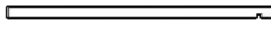
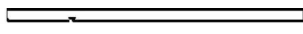
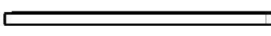

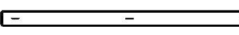
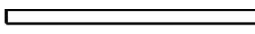
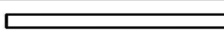
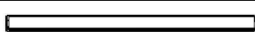
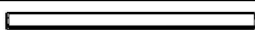
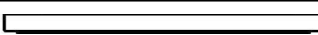
Le dimensioni del piano di base sono le dimensioni della soletta di cemento da realizzare su un terreno perfettamente piatto, senza alcun altro oggetto esterno, come un muro, una recinzione o un albero in prossimità delle soletta. Se il prodotto è installato vicino ad una parete, un recinto o un albero, è necessario distanziarlo adeguatamente, in modo da poterlo facilmente montare e farne la manutenzione. Non ci assumiamo alcuna responsabilità per l'errata interpretazione delle dimensioni delle lastra.

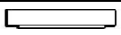

Tolérances à respecter (selon DTU 31.2):

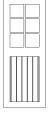
- longueur et largeur: + 0,01m;
- équerrage: +0,01m mesuré sur 10m;
- arase: +0,01m sur une longueur de 10 mètres linéaires alignés ou non et de + 2mm par mètre linéaire;
- rectitude de bords en plan: +5mm .

						Demande sav	
N°	REF	DES.	DIM (mm)	QTE	PLAN	OBS	QTE
1	I42.2.3500		3500 x 65 x 42	1			
2	I42.1.475		475 x 65 x 42	2			
3	I42.1.242		242 x 65 x 42	2			
4	L42.2.3500		3500 x130 x 42	19			
5	L42.1.3198		3198 x130 x 42	2			
6	L42.2.3221		3221 x130 x 42	28			
7	L42.1.2998		2998 x130 x 42	25			
8	L42.1.2998d		2998 x130 x 42	1			
9	L42.0.1723		1723 x130 x 42	8			
10	L42.1.1946		1946 x130 x 42	8			
11	L42.1.475		475 x130 x 42	50			
12	L42.1.242		242 x130 x 42	36			
13a,b	LS42.2.3621		3621 x168 x 42	1+1			
14a,b	LS42.1.3038		3038 x168 x 42	1+1			
15	F62.3500VE		3500 x485 x 62	2			
16	F140.3500VE		3500 x444 x 80	2			
17	GC2430.70		2430 x 70 x 40	1			
18	GC2160.70		2160 x 70 x 40	1			
19	GC2130.70		2130 x 70 x 40	1			
20	GL2430.70		2430 x 70 x 40	4			
21	GL2160.70		2160 x 70 x 40	4			
22	GL2130.70		2130 x 70 x 40	4			
23	EP2160.90.40		2160 x 90 x 40	4			
24	DL2400.90		2400 x 90 x 20	2			
25	DL2100.90		2100 x 90 x 20	4			
26	DSF1900.130		1900 x130 x 20	4			
27	R150.90		150 x 90 x 20	2			
28	TLS2055.42		2055 x130 x 82	1			
29	TLD2055.42		2055 x130 x 82	1			
30	TS2620.42		2620 x130 x 82	1			
31	TLS1950.42		1950 x 90 x 82	1			
32	TLD1950.42		1950 x 90 x 82	1			
33	TS850.42		850 x130 x 82	1			
34	OSB2400.608		2400 x608 x 12	6			
35	OSB2100.608		2100 x608 x 12	12			
36	CA3800.1000		3800x1000x3	7			

						Demande sav	
N°	REF	DES.	DIM (mm)	QTE	PLAN	OBS	QTE
39	U1900.705		1900 x 705 x 28	1			
41	Vis 4,0 x 30		4 x 30	350			
42	Vis metrique 8*100		Vis a ecrou papillon 8*100 mm	12			
46	Vis 3,5 x 35		3,5 x 35	185			
47	Vis 4,5 x 45		4,5 x 45	64			
48	Clous L 80		80	20			
49	Sc1820.20		1820 x 20 x 20	16			
50	Sc1650.28		1650 x 28 x 20	8			
51	DP1990.70		1990 x 70 x 20	1			

A compléter impérativement pour toute demande SAV et à envoyer par mail à sav@foresta.fr + photo des pièces abîmées (To be completed imperatively + Photo of damaged parts)

Dessin de palette avec flèche sur étiquette pour n° colis

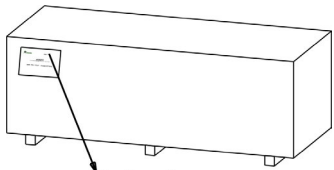

Colis n°: -----

VE 3562S

**Colis
(package) n°**

MAGASIN (STORE)

NOM (NAME)

CLIENT

PRÉNOM(PRE.)

CLIENT

N° de télé-
phone(PHONE)

NOTICE DE MONTAGE

VE 3562S

6/15

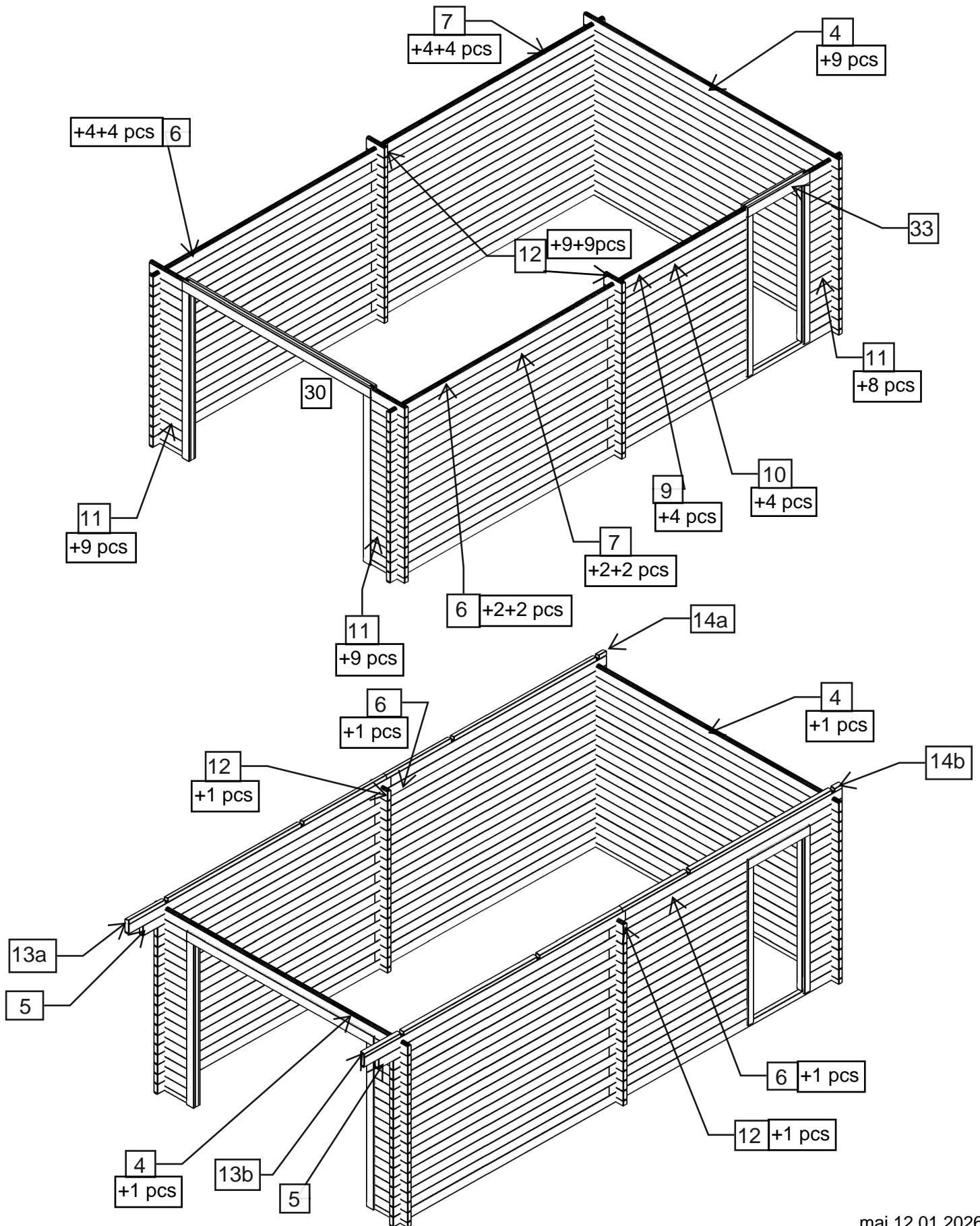

maj 12.01.2026

VE 3562S

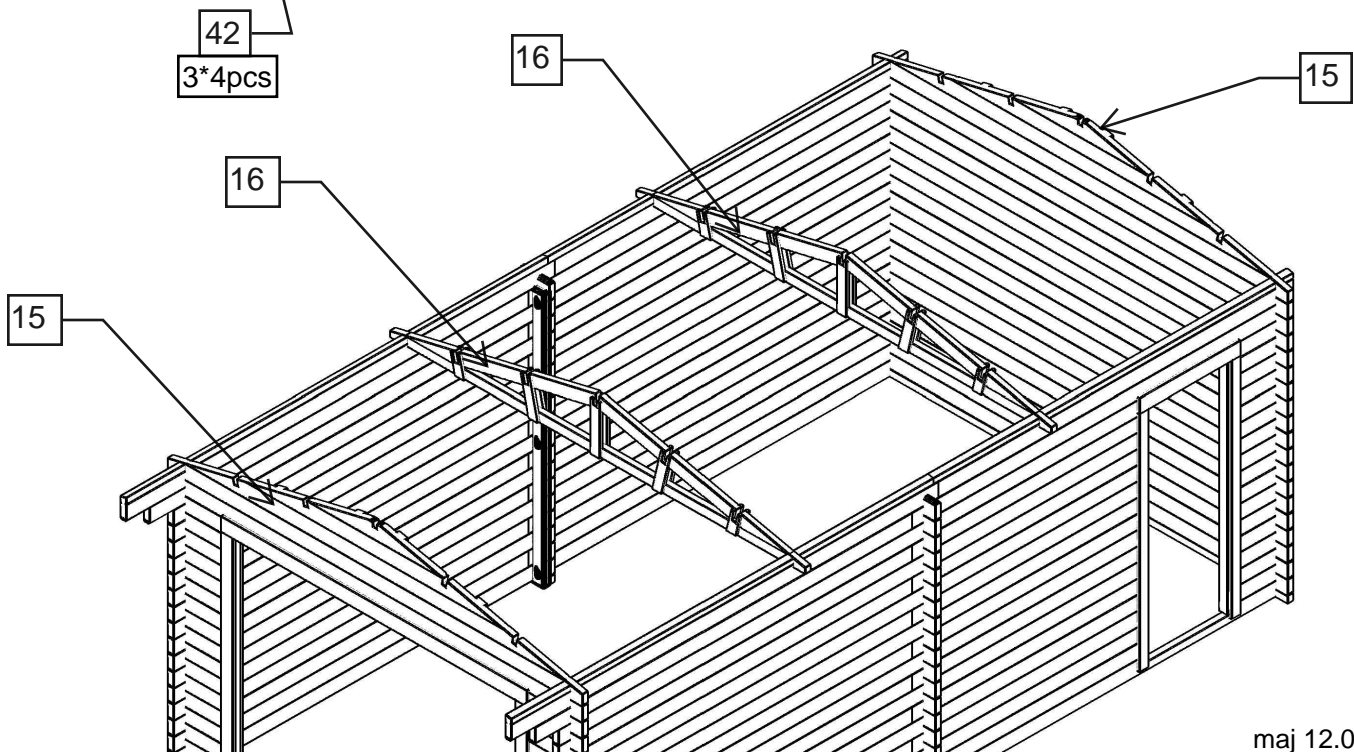
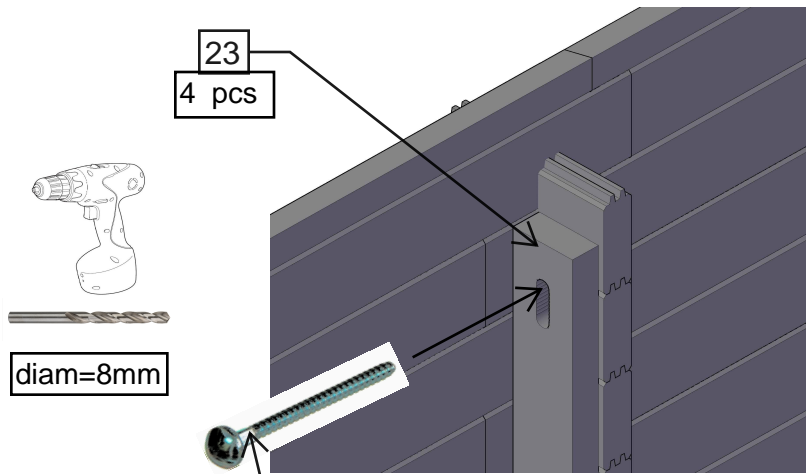
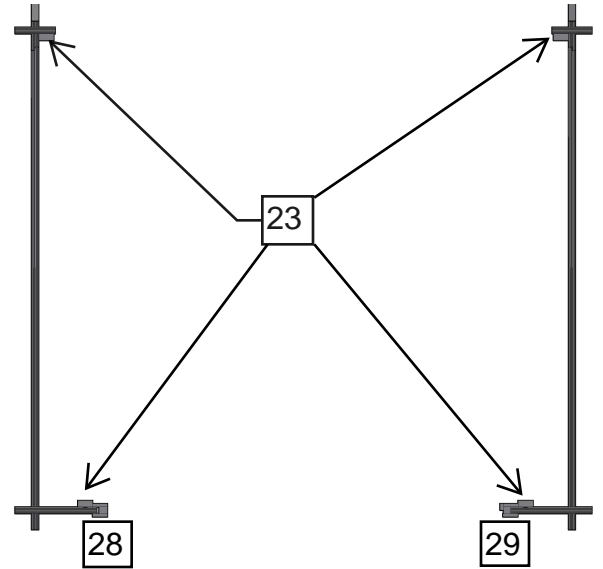
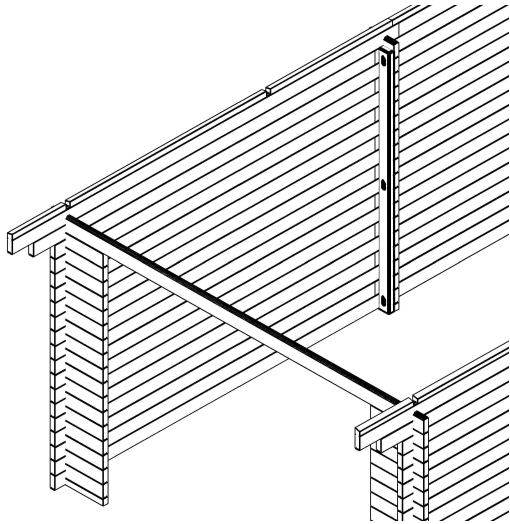

VE 3562S

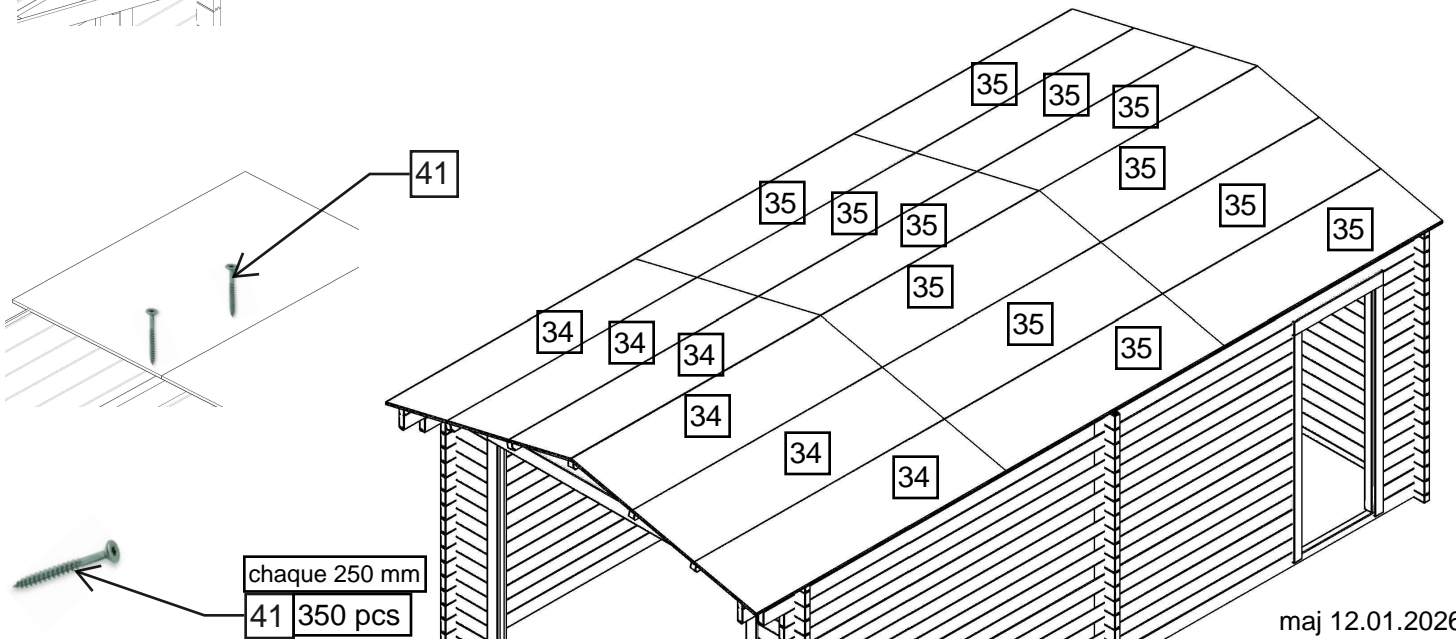
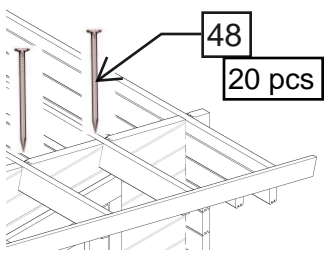
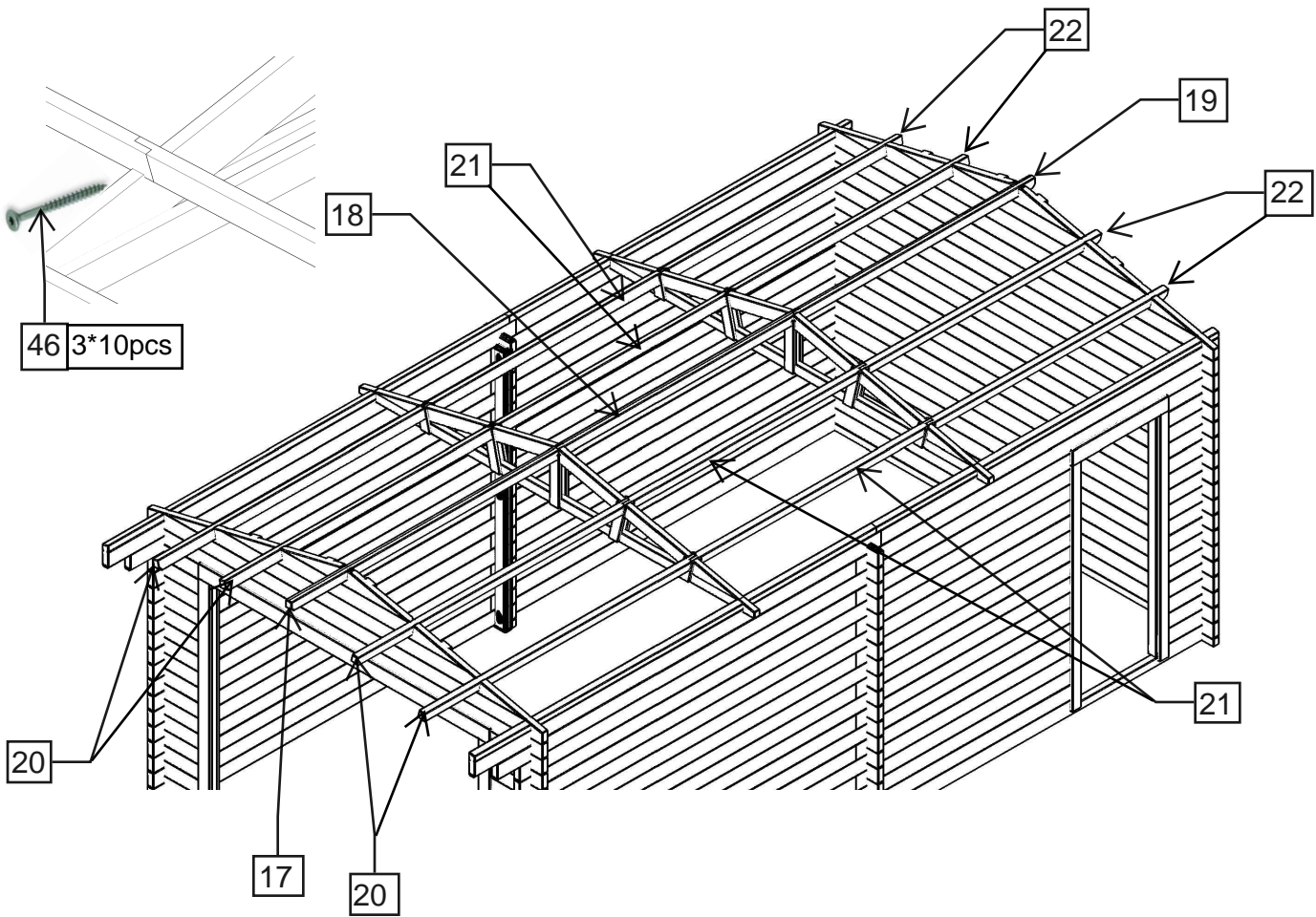

NOTICE DE MONTAGE
VE 3562S

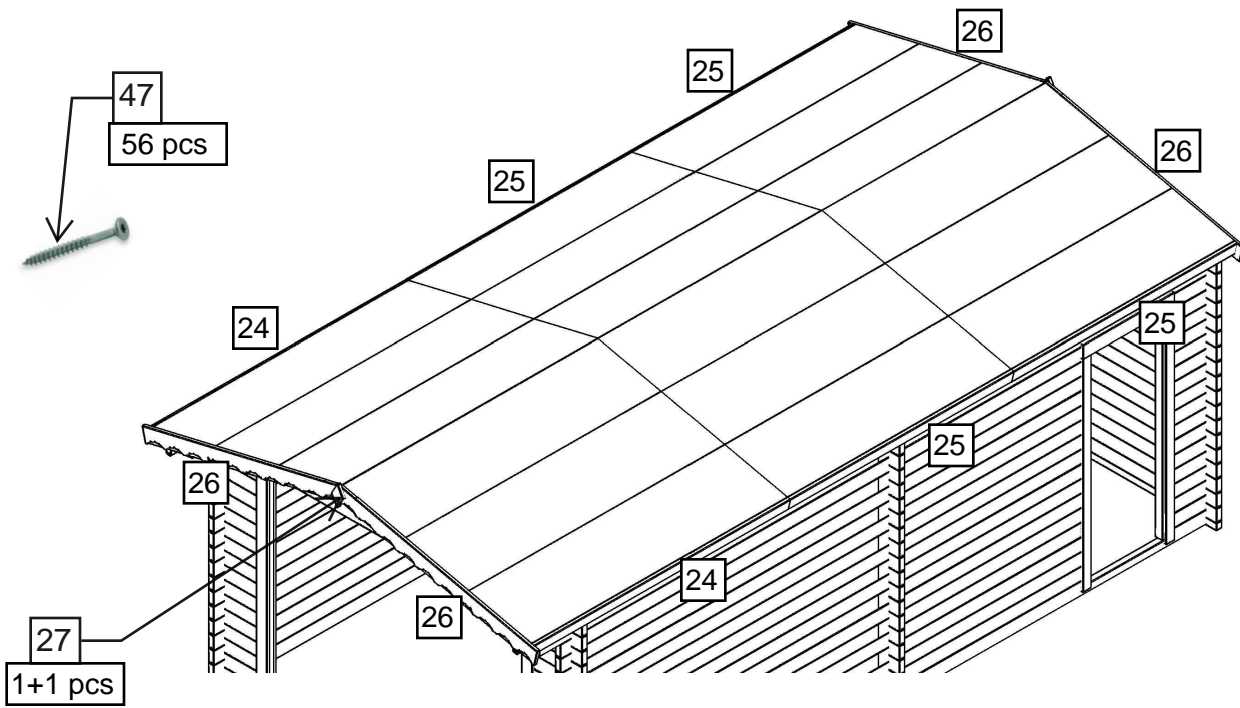

*FIXATION CADRE PORTE**Vue extérieure*

Ne pas visser les vis dans les madriers afin de les laisser travailler librement et éviter les espacements entre madriers.

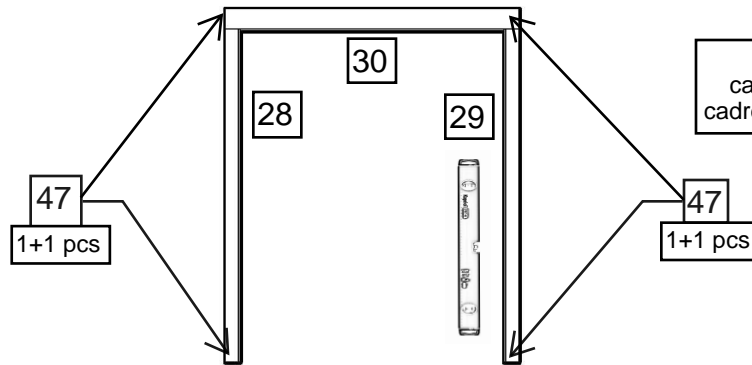

Après avoir réglé les cadres/portes, bloquer les cadres avec les éléments n°23.

*FIXATION CADRE PORTE**Vue extérieure*

Ne pas visser les vis dans les madriers afin de les laisser travailler librement et éviter les espacements entre madriers.

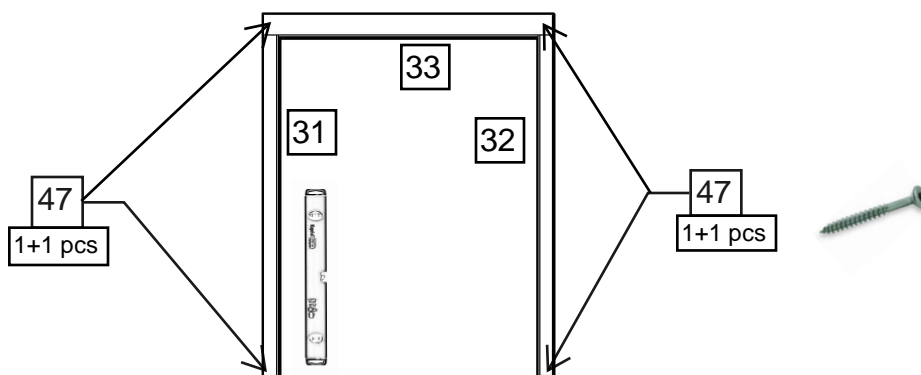

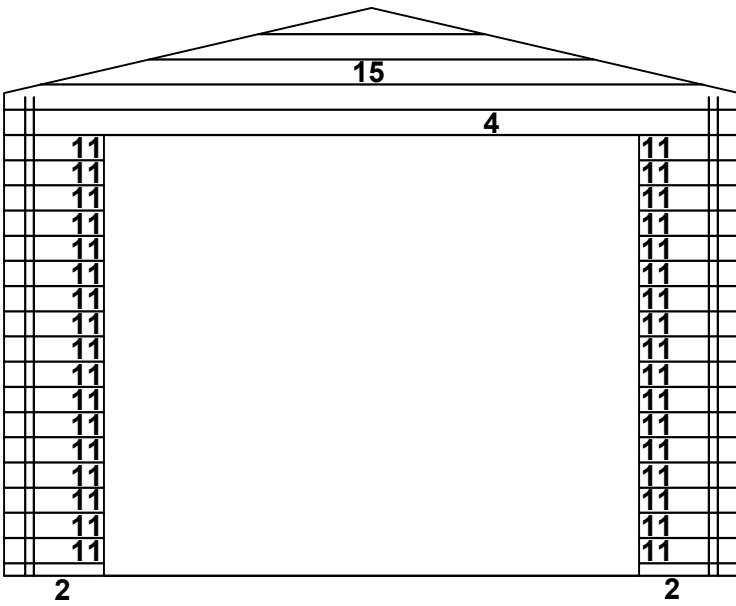

Paroi facade, vue de l'exterieur

Nr.	Qte.	Dimensions (mm)
2	2	475* 65* 42
11	34	475* 65* 42
4	1	3500*130* 42
15	1	3500*485* 62

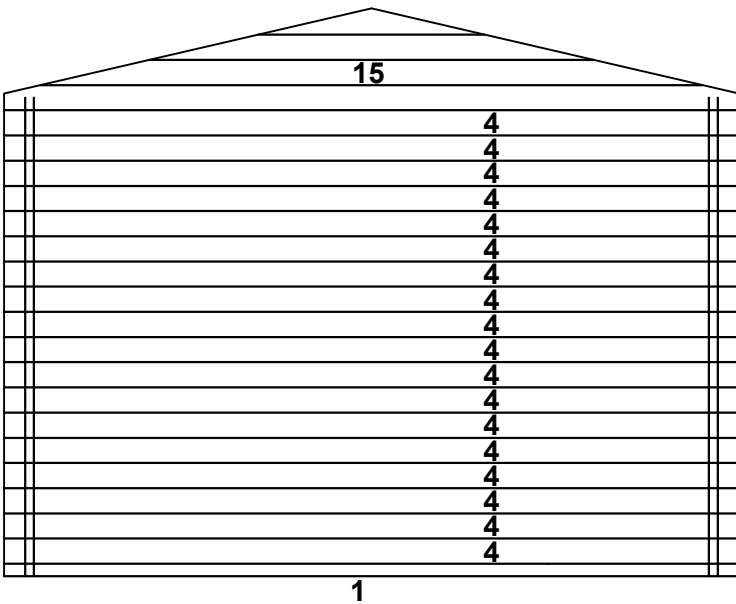

Paroi arriere, vue de l'exterieur

Nr.	Qte.	Dimensions (mm)
1	1	3500* 65* 42
4	18	3500*130* 42
15	1	3500*485* 62

Paroi laterale gauche, vue de l'exterieur

Nr.	Qte.	Dimensions (mm)
6	18	3221*130* 42
7	17	2998*130* 42
5	1	3198*130* 42
13	1	3621*185* 42
14	1	3038*185* 42
3	1	242* 65* 42
12	18	242*130* 42
16	2	3500*444* 80

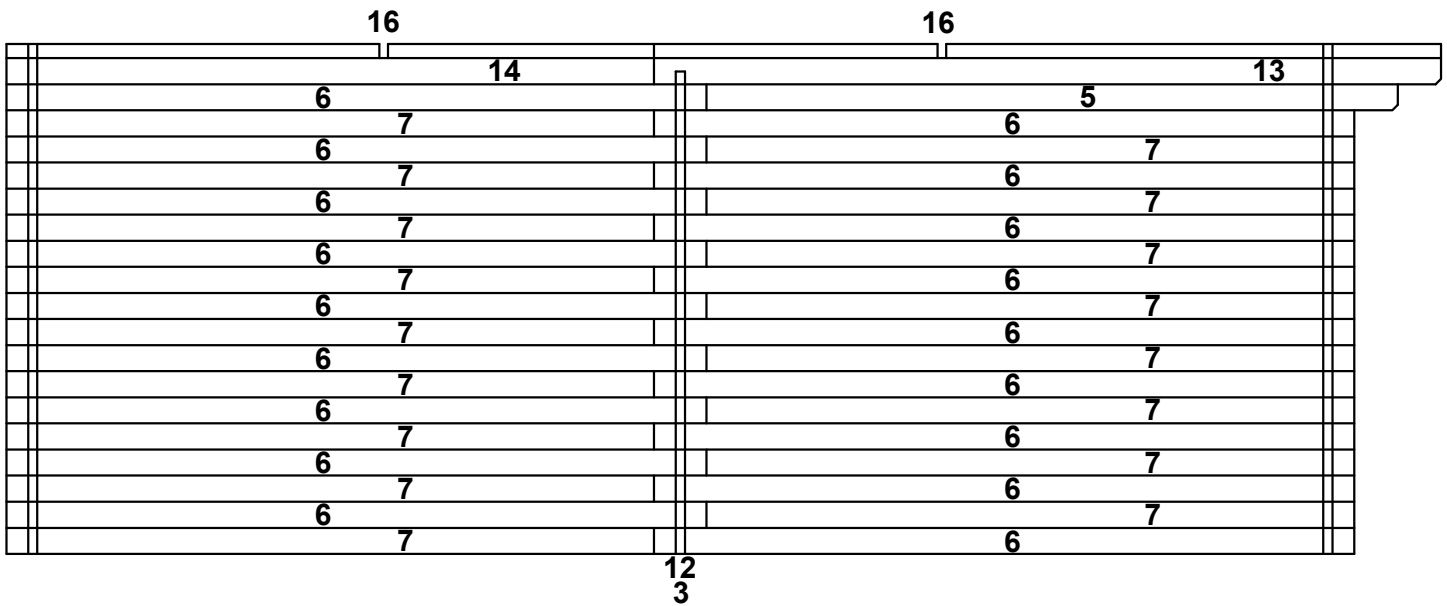

Paroi laterale droite, vue de l'exterieur

Nr.	Qte.	Dimensions (mm)
6	10	3221*130* 42
7	8	2998*130* 42
5	1	3198*130* 42
13	1	3621*185* 42
14	1	3038*185* 42
3	1	242* 65* 42
12	18	242*130* 42
8	1	2998*130* 42
9	8	1723*130* 42
10	8	1946*130* 42
11	16	475*130* 42
16	2	3500*444* 80

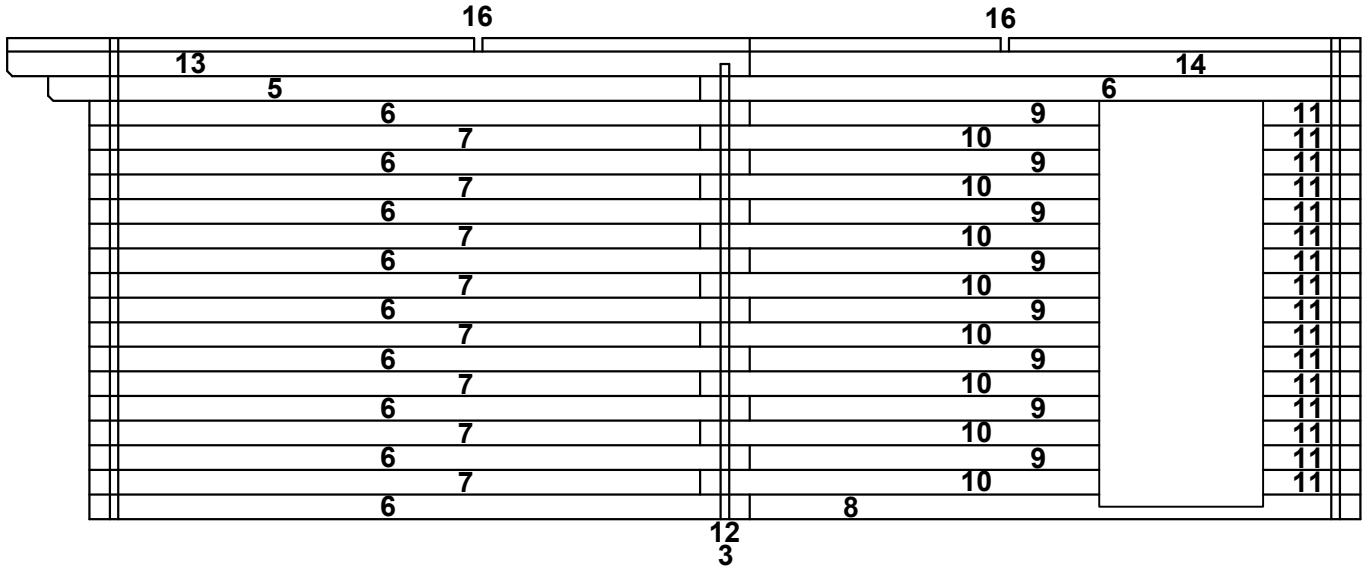

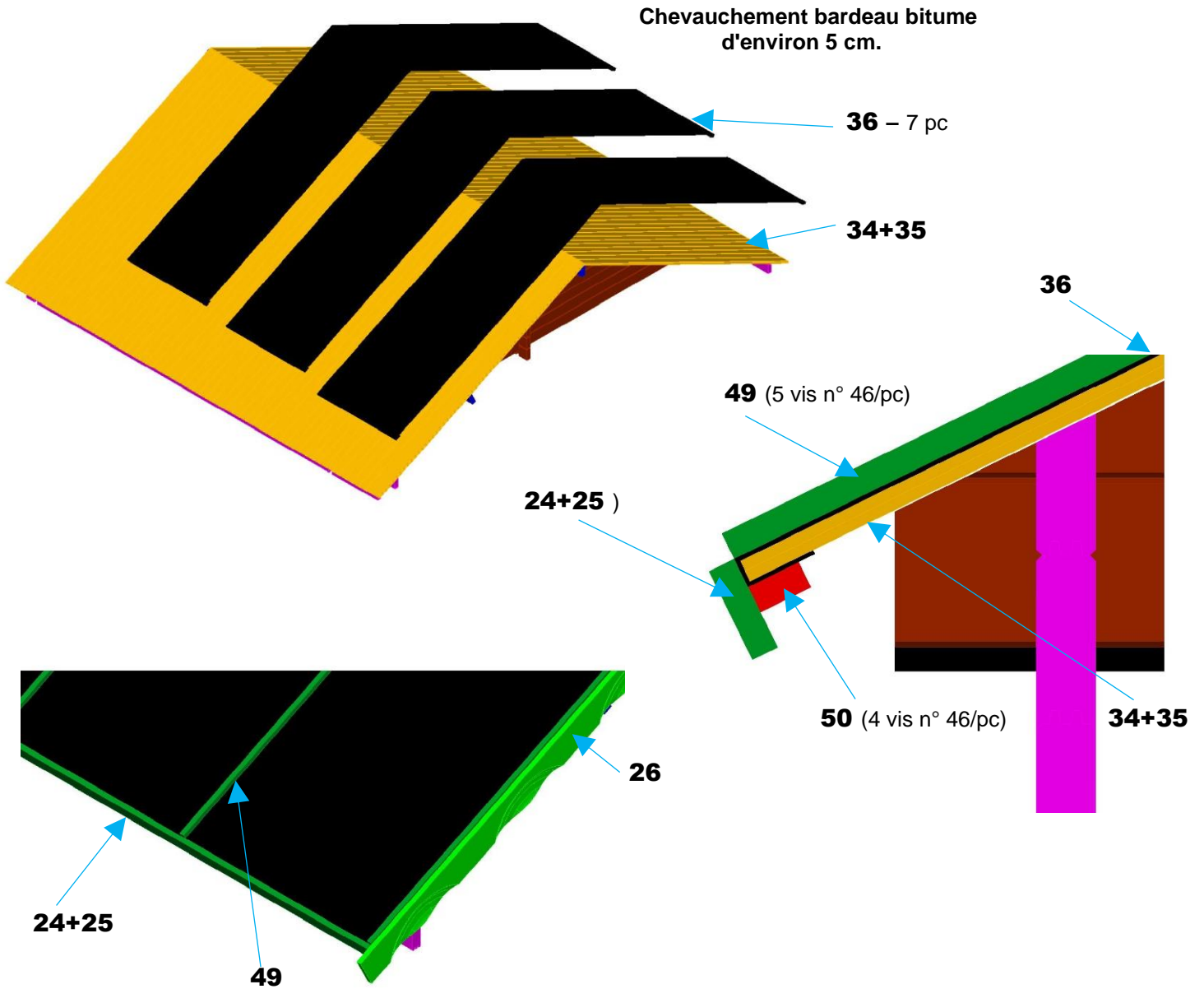

Nr	Reference	Dimension	Piece
49	Sc1820.20	1820 x 20 x 20	16
50	Sc1650.28	1650 x 28 x 20	8

